

Update my dynaco

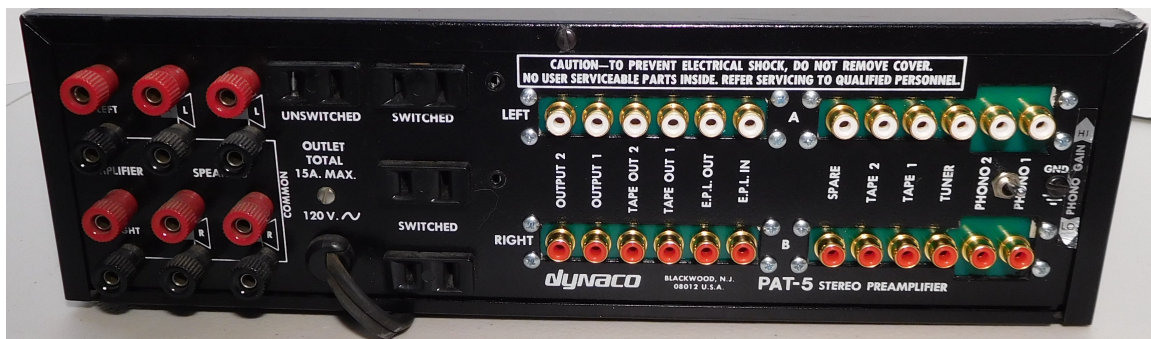

Dynaco PAT-5 Preamp Replacement RCA Jack Installation (PAT5RCA)

© 2016-2024 Akitika LLC

All rights reserved

Revision 1p5

December 7, 2024

Table of Contents

Table of Contents	2
Table of Figures	2
Section 1: About This Manual	3
Who Should Attempt this Project?	3
Tools you'll need	3
Helpful Tools	3
Project Overview	3
Warning.....	3
Important Safety Notes	4
About Components	4
Recommended Solder	4
Warranty	4
Section 2: Kit Building Hints.....	5
Overview of the Process	5
Section 3: Building the New Jack Fields	5
Drilling the Mounting Holes.....	5
Right and Left Channels	5
Installing the Jacks onto the mounting PCB's	6
Adding the Ground Wires and 0.01 μ F capacitors	6
Section 3: Removing the Old RCA Jacks	8
Removing the Cover	8
Gaining Access to the Old RCA Jacks	9
Transfer the 470 pF Capacitors.....	11
Transfer the wires from the old to the new jacks.....	11
Re-installing the new jacks	12
Re-assembling the preamp.....	12
Revisions.....	12

Table of Figures

Figure 1-Assembling RCA jacks to the mounting PCB's.....	5
Figure 2-One of 4 jack-fields, before addition of ground wires	6
Figure 3-Right Channel Jacks with grounds and 0.01 μ F cap	6
Figure 4-Wiring Grounds, lugs, and capacitors on the new jack fields.....	7
Figure 5-Original Jack Field Wiring.....	7
Figure 6-Remove screws to loosen back panel.....	9
Figure 7-Remove two screws that fasten back panel to power supply bracket	9
Figure 8-Accessing Right Channel Jacks	10
Figure 9-Adding the 470 pF caps.....	10
Figure 10-Starting with the jacks side by side makes it easy to correctly transfer the wires	11

Section 1: About This Manual

This manual gives the information needed to build and install new RCA jacks into Dynaco's PAT-5 Preamp.

Who Should Attempt this Project?

You can build this kit if you can:

1. Solder (using normal rosin core solder and a soldering iron).
2. Use simple hand tools like screwdrivers, wire cutters, and pliers.
3. Read and follow directions.

It helps if you:

1. know a bit about electronics, or
2. have a friend who knows a bit about electronics
3. can get to YouTube to watch a few helpful videos about the assembly process (none are posted as of this version of the manual).

Tools you'll need

You'll need the following tools:

1. Phillips screwdriver (#1 and #2), regular screw-drivers.
2. Pliers or nut drivers suitable for #4 and #6 hardware
3. needle nose pliers (helpful, but not strictly necessary)
4. pencil type soldering iron of 25 to 50 Watts (no huge honking soldering guns or blowtorches)
5. wire cutters and strippers

Helpful Tools

These tools aren't strictly necessary, but make building the kit easier.

1. magnifying glass, if you're over 42!

Project Overview

The project consists of the following steps:

1. Building the new RCA jack fields and adding ground wires.
2. Opening up the PAT-5.
3. Transferring two capacitors and all the wires from the old jacks to the new jacks.
4. Reinstalling the new RCA jacks.
5. Closing up the PAT-5.

Warning

This kit is a surprising amount of work. Be sure to take breaks as you work through the steps.

Important Safety Notes

By purchasing, using, or assembling this kit, you have agreed to hold Akitika LLC harmless for any injuries you may receive in its assembly and/or use. To prevent injuries:

- Wear safety glasses when soldering or clipping wires to prevent eye injuries.
- Always unplug the power before working on the amplifier.
- Large capacitors hold lots of energy for a long time. Before you put your hands into the amplifier:
 - Pull the AC plug!
 - Wait 2 full minutes for the capacitors to discharge!
- Remove jewelry and rings from your hands and wrists, or anything that might dangle into the amplifier.
- If working on the equipment with the power on, keep one hand in your pocket, especially if you're near the power supply or power supply wires. This can prevent serious shocks.
- Build with a buddy nearby. If you've ignored all the previous advice, they can dial 911 or get you to the hospital.
- Read and understand the safety manuals of all the tools you use.

About Components

We reserve the right to make design/or component changes at any time without prior notification.

Recommended Solder

The kit must be assembled with 60/40 Rosin Core solder. The recommended diameter is 0.032 inches. Among many such sources of solder, I have used Radio Shack part number 64-009. It contains 8 oz. of solder, which is *much more* than you'll need to assemble this kit.

Warranty

With the exception of fuses, Akitika LLC will replace for free any parts of a correctly assembled product that fails within one year of the date of purchase when the equipment has been used in home stereo applications. It is the responsibility of the kit builder to install the replacement part(s). This warranty applies to the original purchaser only. It does not apply to units that have been physically or electrically abused, modified without prior factory authorization, or assembled with other than 60/40 Rosin Core solder. Akitika LLC's liability shall in no event exceed the cost paid to Akitika LLC for the kit.

Section 2: Kit Building Hints

Yes, I know you want to ignore this section and jump right into building the kit. However, please **take a minute and read the advice.** I've condensed it into bullets so that even you guys who are in a hurry can benefit.

- Stop any time you're feeling confused, tired, or anxious. Taking breaks at those strategic times will keep the build enjoyable and greatly enhance your chances of first-time success.
- A soup bowl is your friend. Before you build, carefully empty the parts for just that board into a broad, flat, light colored soup bowl. That makes it easy to find the parts, and keeps them from getting lost.
- Is something in this manual confusing? Does something look wrong? Send your questions by email to dan@akitika.com or dan@updatemydynac.com. You'll help yourself and everyone who builds the kit.

Overview of the Process

The project consists of the following steps:

1. Building the new RCA jack fields and adding ground wires.
2. Opening up the PAT-5.
3. Transferring two capacitors and all the wires from the old jacks to the new jacks.
4. Reinstalling the new RCA jacks.
5. Closing up the PAT-5.

Section 3: Building the New Jack Fields

Drilling the Mounting Holes

Each of the jack fields has four mounting holes. To use them in the PAT-5, you should drill these holes out using a 5/32" drill. **This will make fastening the jack fields into the PAT-5 much easier.**

The following drawing shows how all the jacks are assembled onto the jack fields.

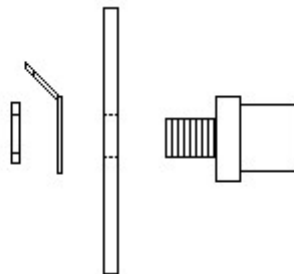

Figure 1-Assembling RCA jacks to the mounting PCB's

Right and Left Channels

Each kit is supplied with 24 RCA jacks:

- 12 red-insulator RCA jacks for the right channel
- 12 white-insulator RCA jacks for the left channel.

Installing the Jacks onto the mounting PCB's

If you have it, an 11/32" nut driver¹ can make assembly much easier. You'll assemble the four identical copies of the following. Please note that:

- Two will be built using red-insulator jacks, used for the right channel
- Two will be built using white-insulator jacks, used for the left channel
- Note that orientation of the curved surface of the "hot" terminal.



Figure 2-One of 4 jack-fields, before addition of ground wires

Here's a hint about getting the jacks in the right position and tightened up. Get the jack, ground lug, and nut finger tight and on "10 o'clock". Take the last partial turn with a nut driver. With a bit of practice, the partial turn makes everything tight, and sitting in the right position.

Adding the Ground Wires and 0.01 μ F capacitors

Figure 3 shows our goal at the end of this section. A similar result is constructed with white insulator RCA jacks for the left channel.



Figure 3-Right Channel Jacks with grounds and 0.01 uF cap

In this section, you'll add ground wires in the indicated places, using the black, solid 22 AWG wire supplied with the kit. The picture in Figure 4 has the following color code:

- Hot pink – bare 22 AWG wire (just strip a bit of the supplied black 22 AWG and use in the inner conductor).
- Black – use black 22 AWG stripped in the normal way.

Please refer to the next two Figures as you build and change out the jack fields. They show the new and original jack field ground wiring. It may help to print a copy of this page for reference while you look at the instructions that follow.

¹ A 9 mm metric driver works fine also.

BACK PANEL GROUND CONNECTIONS

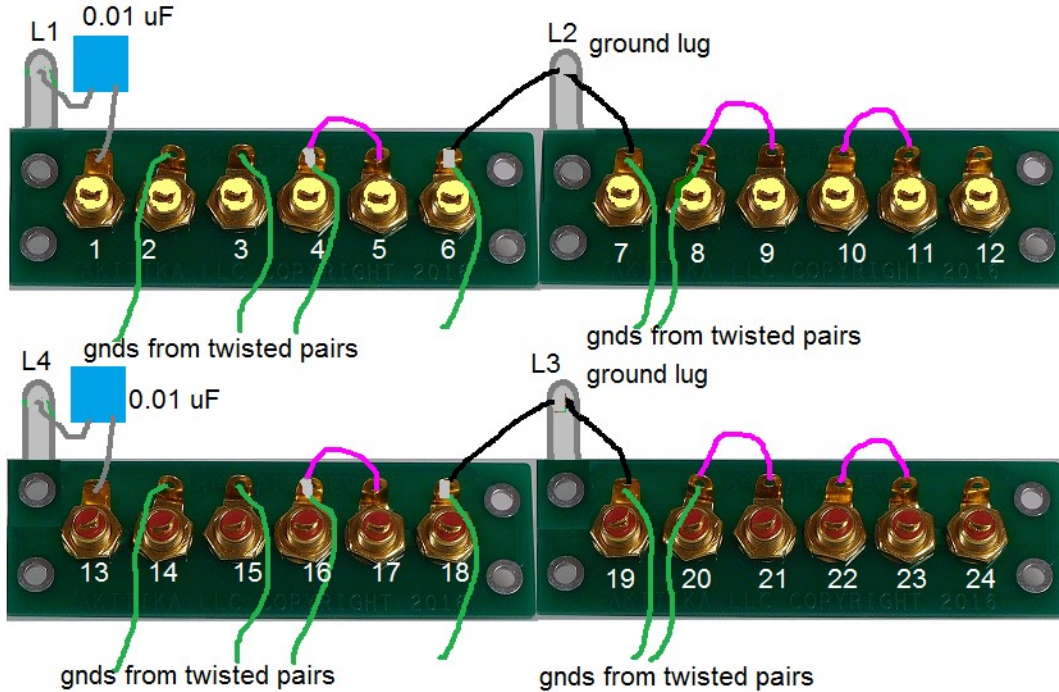

Figure 4-Wiring Grounds, lugs, and capacitors on the new jack fields

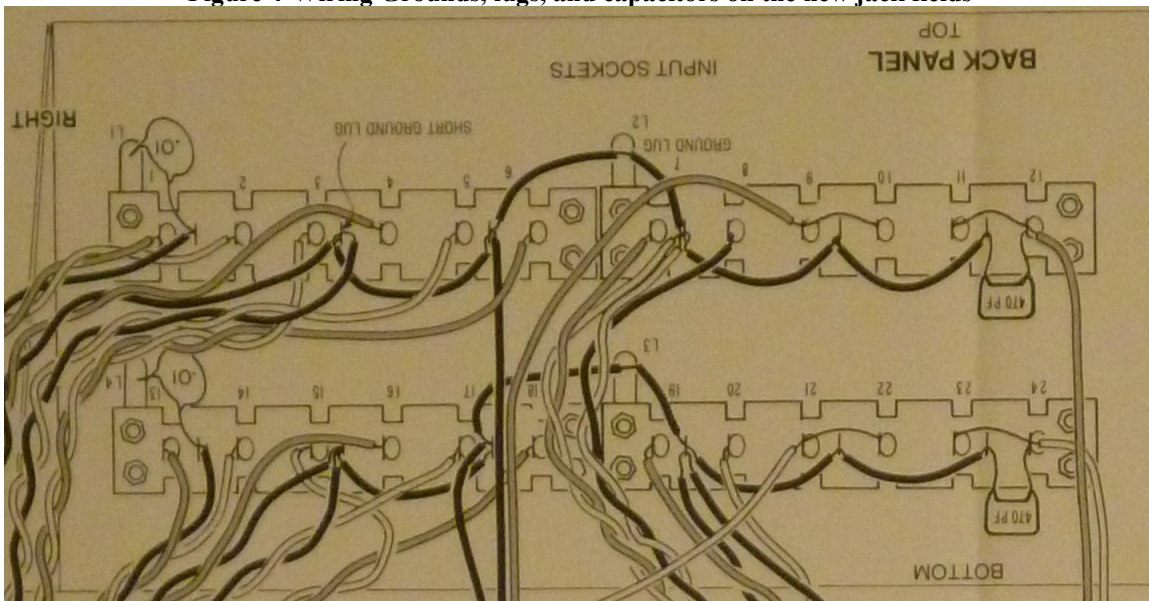

Figure 5-Original Jack Field Wiring

Step by step instructions follow. You'll perform these instructions twice, once for the Right Channel (RED) jack fields, and a second time for the Left Channel (WHITE) jack fields.

1. Solder a bare wire between the grounds of jack 10 and 11. Keep the wire reasonably short. It's actually easier if you strip the insulation and use a piece of bare wire soldered between the two terminals. Refer to Figure 3.

2. Solder a bare wire between the grounds of jack 8 and 9. Keep the wire reasonably short. Try to leave room in the jack 8 hole as another ground wire from the preamp terminates there (added in a later step).
3. Solder a bare wire between the grounds of jack 4 and 5. Keep the wire reasonably short. Try to leave room in the jack 4 hole as another ground wire from the preamp terminates there (added in a later step).
4. Connect the ground of jack 6 to one of the supplied 6-32 lugs (L2) using insulated 22 AWG wire.
 - a. Try to leave room on the jack 6 side to accommodate another ground wire from the preamp that terminates there in a later step.
 - b. Note the way the mounting hole of the lug must align with the mounting hole of the terminal strip, and make sure your wire lengths will allow this.
5. Connect the ground of jack 7 to one of the supplied 6-32 lugs (L2) using 22 AWG insulated wire. Try to leave room on the jack 7 side to accommodate another ground wire from the preamp that terminates there in a later step.
6. Solder one of the supplied 0.01 uF capacitors between lug L1 and the ground of jack 1.
7. Solder a bare wire between the grounds of jack 22 and 23. Keep the wire reasonably short.
8. Solder a bare wire between the grounds of jack 20 and 21. Keep the wire reasonably short. Try to leave room in the jack 20 hole as another ground wire from the preamp terminates there (added in a later step).
9. Solder a bare wire between the grounds of jack 16 and 17. Keep the wire reasonably short. Try to leave room in the jack 16 hole as another ground wire from the preamp terminates there (added in a later step).
10. Connect the ground of jack 18 to one of the supplied 6-32 lugs (L3) using insulated black 22 AWG wire.
 - a. Try to leave room on the jack 6 side to accommodate another ground wire from the preamp that terminates there in a later step.
 - b. Note the way the mounting hole of the lug must align with the mounting hole of the terminal strip, and make sure your wire lengths will allow this.
11. Connect the ground of jack 19 to one of the supplied 6-32 lugs (L3) using insulated black 22 AWG wire.
12. Try to leave room on the jack 19 side to accommodate another ground wire from the preamp that terminates there in a later step.
13. Solder the remaining of the supplied 0.01 uF capacitor between lug L4 and the ground of jack 13.

Section 3: Removing the Old RCA Jacks

Removing the Cover

1. Disconnect your PAT-5 from your system.
2. Pull your PAT-5's power cord out of the AC wall socket.
3. Pull any power cords that are plugged into your PAT-5's convenience outlets.
4. Remove the 4 screws (two on each side) that hold the cover in place and the screw in the center of the back-panel cover.

5. Remove the cover and set it aside in a safe place.

Gaining Access to the Old RCA Jacks

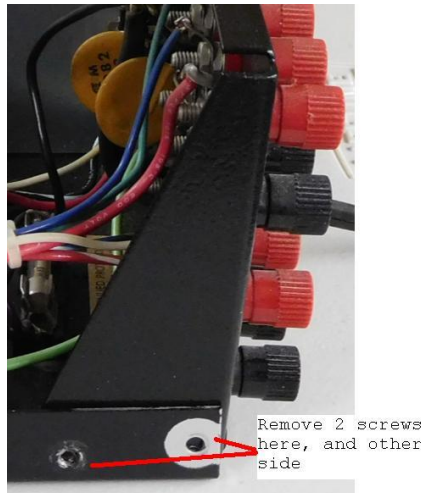

Figure 6-Remove screws to loosen back panel

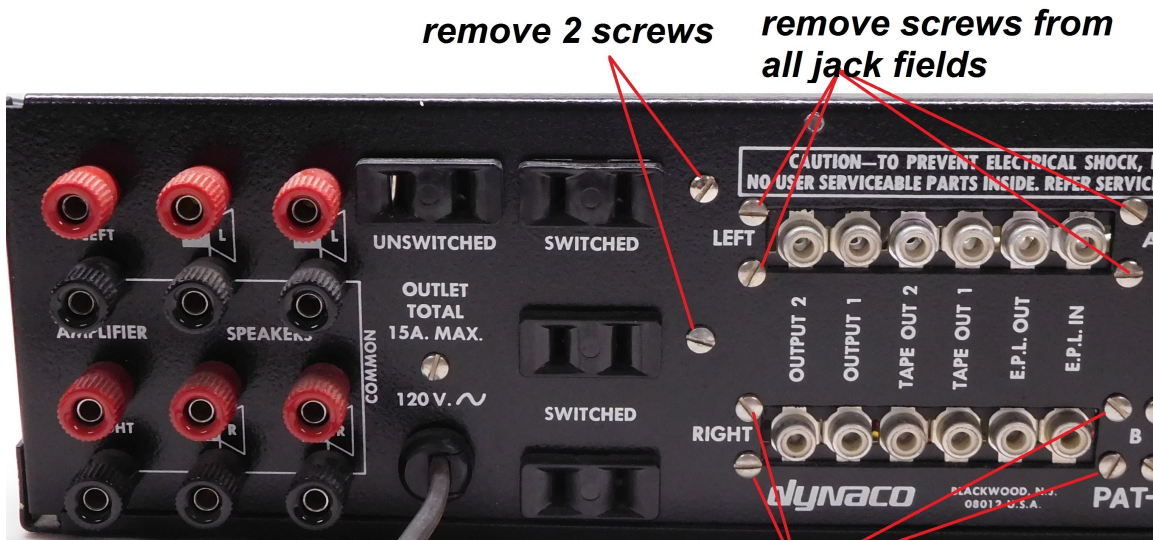

Figure 7-Remove two screws that fasten back panel to power supply bracket

Removing the jacks may be made much easier by loosening the back-panel. Remove four screws (refer to Figure 6) and two screws (Figure 7) that fasten the back panel to the power supply bracket. At that point, you will be able to lift the back panel and tilt it back. Be careful not to put too much strain on the wires that run from the chassis to the back panel.

Now remove the sixteen 4-40 screws that hold the jack fields in place. Figure 7 shows 8 of the 16 screws that hold the jack fields in place. All 16 screws must be removed to allow the jack fields to be removed.

You can gain access to the Left channel jacks by raising them above the back panel. You can gain access to the Right channel jacks by lowering them below the back panel.

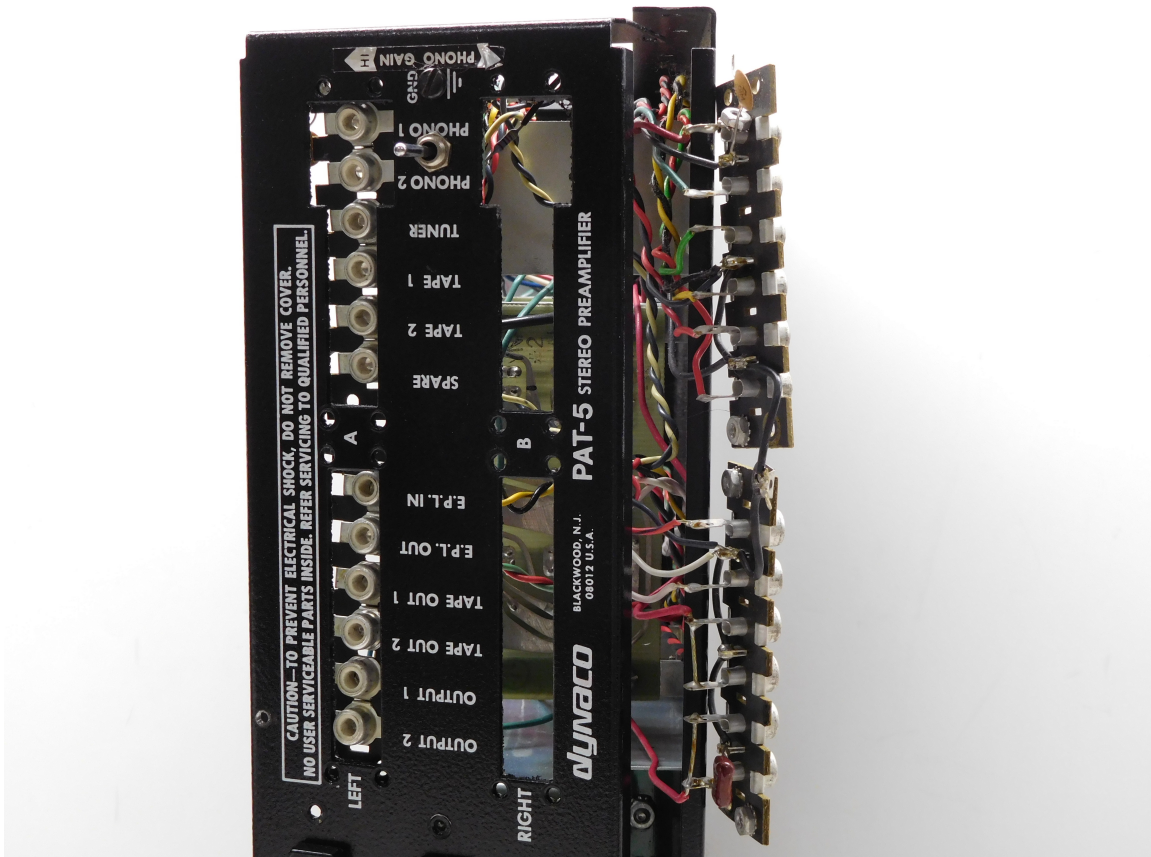

Figure 8-Accessing Right Channel Jacks
BACK PANEL GROUND CONNECTIONS

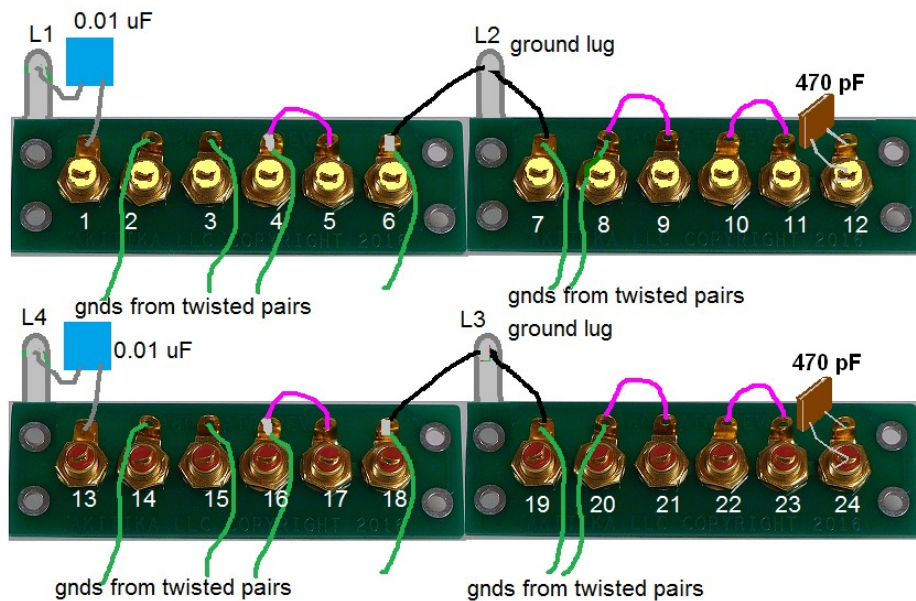

Figure 9-Adding the 470 pF caps

Transfer the 470 pF Capacitors

Note that the right side of Figure 5 shows two 470 pF caps associated with jack 12 and jack 24. Carefully de-solder those two caps.

1. Install one of those caps between the center (hot) terminal of jack 12 and its associated ground terminal. Try to leave room in the hot terminal for a wire that will be added in a later step.
2. Install the other of those caps between the center (hot) terminal of jack 24 and its associated ground terminal. Try to leave room in the hot terminal for a wire that will be added in a later step.

Transfer the wires from the old to the new jacks

For all of the wires that connect to the RCA jacks, follow this procedure:

1. Remove 1 wire from the original jack fields.
2. Move that wire to the same place in the new jack field.
3. Continue that procedure until all of the wires have been moved over to the new jack fields.

I found it easiest to keep the new and old jacks side by side.

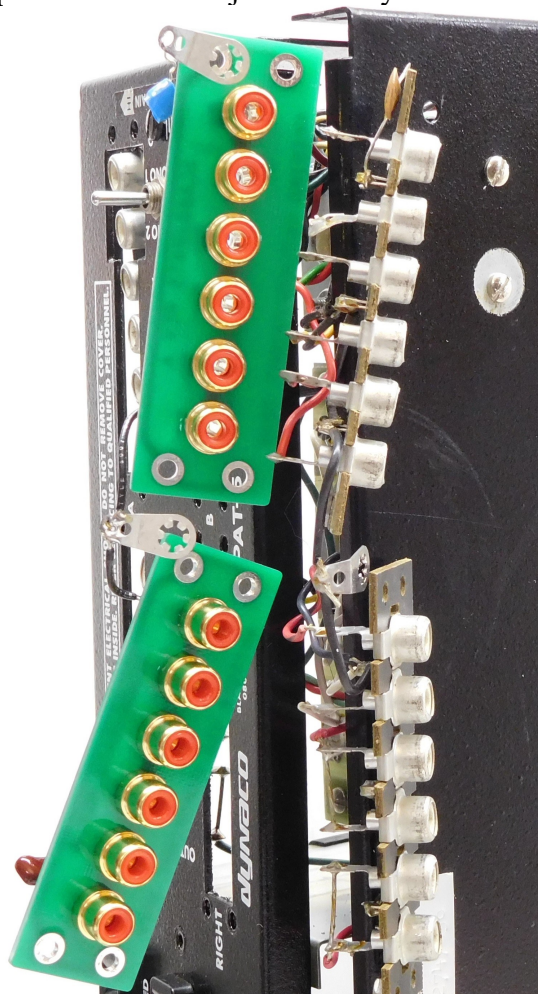

Figure 10-Starting with the jacks side by side makes it easy to correctly transfer the wires

You'll definitely find that it's tight quarters. On my PAT-5, I cut all the wires close to the original jacks, and had enough slack to move them to the new jacks. You might choose to de-solder the wires from the old jack. I worked one jack field at a time, and transferred just one wire at a time.

Re-installing the new jacks

Work the new jacks carefully back into the chassis, being careful not to over-stress the (mostly) solid wires that connect them. Some hints:

- Install the screws and nuts loosely.
- Make sure that the lugs sit between the chassis and the RCA jack PCB.
- A little sticky tape on the end of a screw-driver makes a nice way to hold 4-40 nuts in hard-to-get-to places until you can get the screw started.
- I hope you took my advice on page 5 and drilled the four corner mounting holes out to 5/32". Doing this will avoid lots of swear words.

Re-assembling the preamp

1. Re-install the two 4-40 screws and nuts that fasten the back panel to the power supply mounting plate.
2. Re-install the 5 screws that hold the PAT-5's cover in place.

Revisions

- 1p5 – adds reminder to drill out the 4 corner mounting holes to 5/32".