

PAT-4 PHONO PREAMP REPLACEMENT (PAT4PPR) ASSEMBLY MANUAL

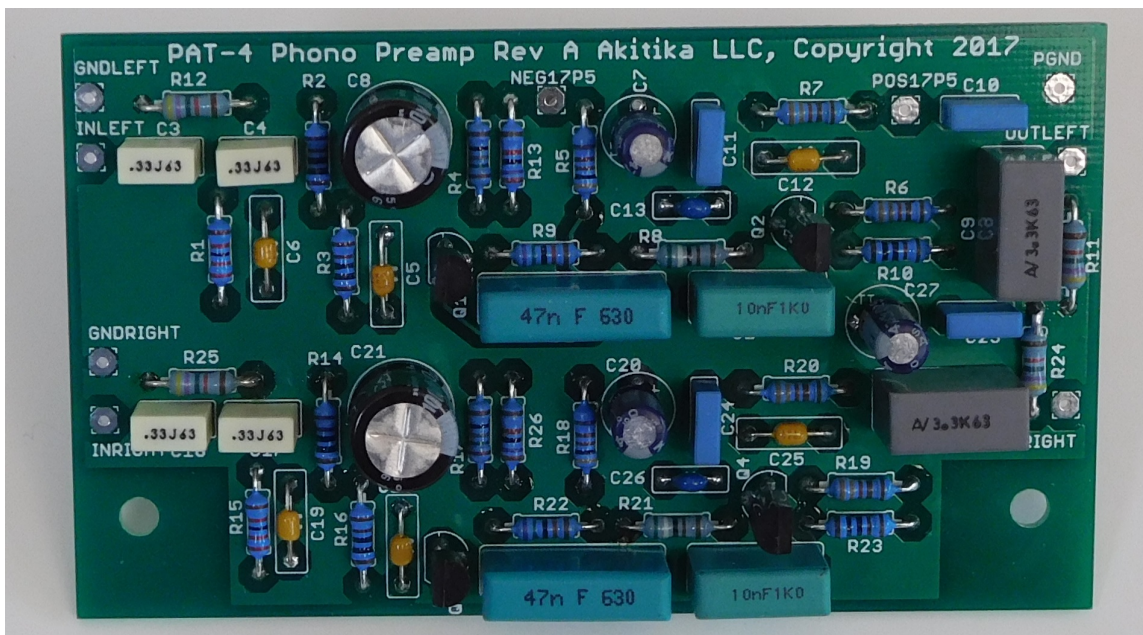

© 2019 Akitika, LLC
All rights reserved
Revision 2p00 December 8, 2019
Covers Rev D kits having Rev D PCB's

Table of Contents

Table of Contents	2
Table of Figures	2
Section 1: About This Manual	4
Who Should Attempt these Projects?	4
Tools and Supplies You'll Need	4
Recommended Solder	5
Project Overview	5
Important Safety Notes	5
Section 2: About the Phono Preamp Upgrade	6
Effects of the Modification	6
Prerequisites	6
Building the PAT4PPR Circuit Boards	6
Component Order	7
Install the Resistors	7
Prepare and Add Shielded Cables to the Inputs	10
Install the Mounting Brackets	11
Preparing to Install the Assembled PAT4PPR Circuit Board	11
Drilling Mounting Holes in the PAT-4 Chassis	11
Connect the RCA Jacks	12
Move Power Wires	13
Move Selector Switch Wires	14
Converting to Accept 5 high level inputs and 1 phono input	14
Inspection and Preliminary Reassembly	17
Final Sanity Checks	17
Prepare to Reconnect your PAT-4 to your Music System	17
Record Playing Reminders	17
Gain Tweaks	18
More Tweaks	18
Schematics	19
Specifications	21
Appendix 1: The Toothpick Trick	22
Appendix 2 - Preparing a Shielded Cable End	23
Appendix 3 - Resistor Color Code	25

Table of Figures

Figure 1-Component side of the phono preamp PCB before loading	6
Figure 2-Installing resistors	7
Figure 3-Orientation of the BCX38C transistor	10
Figure 4-Shielded cable installation (right channel shown here)	10
Figure 5-Use 6-32x1/4" screws to attach mounting brackets	11
Figure 6-Locating the mounting holes	11
Figure 7-locating the two added 9/64" mounting holes	12
Figure 8-Connecting Left Channel input jack and 0.01 μ F capacitor	12
Figure 9-Selector Switch wire identification	14

Figure 10-Back Panel Re-wiring	16
Figure 11-Phono Preamp Schematic Page 1	19
Figure 12-Phono Preamp Schematic Page 2.....	20
Figure 13- Shield wire end prep completed (right channel)	24
Figure 14-demonstrating the resistor color code	25

Section 1: About This Manual

This manual gives the information you need to build and install the PAT-4 Phono Preamp Replacement (and Upgrade), part number PAT4PPR, into your Dynaco PAT-4 Preamp. This revision of the manual covers the Rev D PC board. It has wider traces that should be easier to solder than previous versions. It also changes the type of Darlington transistors from MPSA45 to BCX38C. As of this writing, the following other PAT-4 upgrades are available from Updatemydynaco, a division of Akitika LLC:

- Blue Light Kit (BLUE)
- Line Amp Distortion Reducer (DRD4)
- Tone Control Switch (TCS)
- Electronically Regulated Power Supply (PAT4PWR)
- Line Stage Replacement Components (P4LSRC)
- Phono section upgrade (PAT4LP)

In my opinion, this kit, the PAT4PPR is preferable to the PAT4LP, even though the PAT4PPR costs more. Why?

- The PAT4PPR kit is easier to build and install than the PAT4LP kit.
- The PAT4PPR kit has a tight layout with ground-planes and bypass capacitors that give it great high-frequency stability and noise rejection.
- The PAT4PPR kit has a built-in second order high-pass filter that minimizes the woofer wobble caused by record warp.
- The PAT4PPR kit has a built-in second-order lowpass filter that makes it much less likely to pick up external signals like switching transients and radio stations.
- The PAT4PPR is installed much farther from the power supply, so picks up much less of the stray hum fields inside the PAT-4. This makes it very quiet and free of hum. The only hum you will pick up comes from the phono cables outside of the PAT-4.

Note: the phono upgrade kit requires the PAT4PWR supply to be installed.

Who Should Attempt these Projects?

You can build this kit if you can:

1. solder (using normal rosin core solder and a soldering iron),
2. use simple hand tools like screwdrivers, wire cutters, and pliers, and
3. Read and follow directions.

It helps if you:

1. know a bit about electronics, or
2. have a friend who knows a bit about electronics
3. can get to YouTube to watch a few helpful videos about the assembly process (not available as of this version of the manual)

Tools and Supplies You'll Need

You'll need the following tools:

1. flat blade screwdrivers for #4 and #6 screws, #2 Philips head screwdriver

2. a power drill with a 9/64" drill bit. A center punch is also helpful, as you will be drilling two holes into the bottom of the PAT-4 Chassis.
3. needle nose pliers (helpful, but not strictly necessary)
4. pencil type soldering iron of 25 to 50 Watts (no huge honking soldering guns or blowtorches)
5. wire cutters and strippers
6. de-soldering tools (see the Appendix 1 and Appendix 2)
7. Magnifying glass, if you're over 42!
8. A multi-meter for measuring Ohms and DC volts is handy, but not strictly necessary

Recommended Solder

The kit must be assembled with 60/40 Rosin Core solder. The recommended diameter is 0.032 inches. Among many such sources of solder, I have used Radio Shack part number 64-009. It contains 8 oz. of solder, which is *much* more than you'll need to assemble this kit.

Project Overview

Broadly, the project consists of the following steps:

1. Building the PAT4PPR circuit board.
2. Adding two screw holes to the bottom of the chassis.
3. Transferring a few wires from the phono preamp section of the original preamp circuit boards to the new phono preamp.
4. Fastening the new phono preamp in place and performing a few sanity checks.
5. Reassembling the preamp.

Important Safety Notes

By purchasing, using, or assembling this kit, you have agreed to hold Akitika, LLC harmless for any injuries you may receive in its assembly and/or use. To prevent injuries:

- Wear safety glasses when soldering to prevent eye injuries.
- Always unplug the power before working on the equipment.
- Large capacitors hold lots of energy for a long time. Before you put your hands into the equipment:
 - Pull the AC plug!
 - Wait 1 full minute for the capacitors to discharge!
- Remove jewelry and rings from your hands and wrists, or anything that might dangle into the amplifier.
- If working in the amplifier, keep one hand in your pocket, especially if you're near the power supply or power supply wires. This can prevent serious shocks.
- Build with a buddy nearby. If you've ignored all the previous advice, they can dial 911 or get you to the hospital.

Section 2: About the Phono Preamp Upgrade

Effects of the Modification

- The phono preamp will be at least 4 dB quieter than the stock preamp. Internally generated hum will be reduced by much more than that.
- The phono equalization will be much more accurate, providing truer sound.
- You will change the wiring to provide 5 high level inputs and 1 phono input:
 - The PHONO LOW input will be active, accepting a moving magnet cartridge.
 - Tape Head and Special inputs will be converted to accept high level inputs
- The preamp won't clunk when you switch it in and out of the phono position.
- Your cartridge will see the correct loading impedance. The original PAT-4 design used a form of feedback biasing that made its input impedance look inductive, falling to 10K ohms or less at low frequencies. This kit presents an input impedance that looks very much like 47 K Ohms in parallel with 220 pF across the whole audio band.

Prerequisites

The PAT4PWR supply must be installed along with the phono preamp upgrade. The reason is that the PAT4PWR supply generates a -17.5 Volt supply that is used to bias the phono preamp in the PAT4PPR.

Building the PAT4PPR Circuit Boards

This section details the process of building the phono preamp circuit board. We start with an overview on this page. The specifics you need to start building begin on the next page.

The bare PCB is shown in Figure 1.

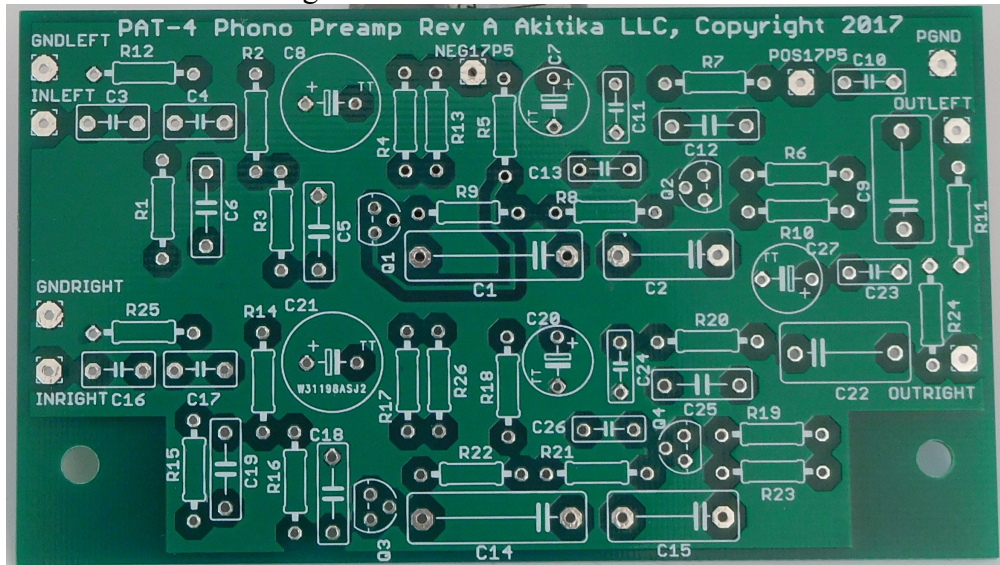
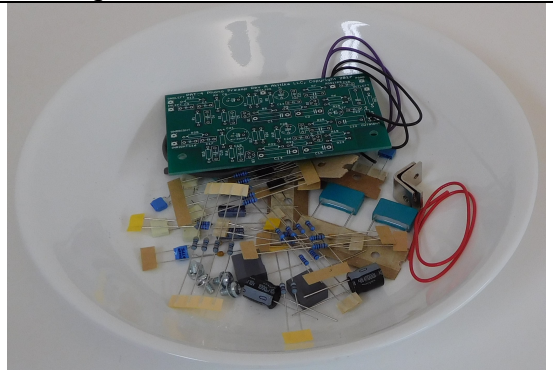

Figure 1-Component side of the phono preamp PCB before loading

Begin by carefully emptying the contents of the parts envelope into a broad soup bowl, as shown below. In general, you'll start with the components that lay closest to the board, working your way towards the taller components. You will:

1. Install the resistors
2. Install the capacitors
3. Install the transistors



Component Order

You'll notice that the component designations in the directions don't go exactly in order. We have grouped them so that all components with the same value appear together. This makes assembly easier. You'll find in the parts kit that similar parts, e.g. 3 1K resistors, are typically (though not always) taped together.

Install the Resistors

In general, you install the resistors by placing the body on silk screen side of the board, and the leads through the indicated holes. Bend the leads over on the back of the board to keep the resistors from falling out until you solder them in place. Try to bend the leads in a direction that won't lead to solder bridges between traces that should remain disconnected.

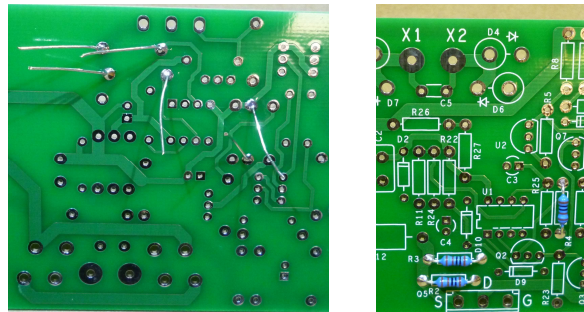

Figure 2-Installing resistors

We recommend the following procedure:

1. Insert all the resistors of the same value, e.g. R4 and R7.
2. Bend the leads as described above.
3. Solder the leads on the back of the board.
4. Clip the leads.

Track your progress by placing a check-mark in the done column as you install each resistor. Check resistor values with a meter, or by reading the color code¹. Orient the

¹ See "Appendix 3 - Resistor Color Code" on page 24 to see how to read resistor color codes.

resistor with the fat brown band on the right, then you can read both the Color Code column and the resistor from left to right.

Here are two assembly hints:

1. Finding the components: The PC Board has two essentially identical layouts, one for each channel:
 - a. Left channel along the top half of the PCB.
 - b. Right channel along the bottom half of the PCB
 - c. You'll often find that pairs of identical resistor values are separated by 13. For example:
 - i. R4 and R17, separated by 13, are both 158 Ohms.
 - ii. R4 and R17 are in essentially the same left to right position on the PCB, with R4 in the left channel, and R17 in the right channel.
2. The resistor leads are spaced at 0.4". If you have a lead bender, this will speed up and neaten your assembly. A lead bender is not required.

Desig	Value	Marking	Done <input checked="" type="checkbox"/>
R4	158	Brown, green, gray, black, brown	<input type="checkbox"/>
R17	158	Brown, green, gray, black, brown	<input type="checkbox"/>
R2	1k	Brown, black, black, brown, brown	<input type="checkbox"/>
R3	1k	Brown, black, black, brown, brown	<input type="checkbox"/>
R10	1k	Brown, black, black, brown, brown	<input type="checkbox"/>
R14	1k	Brown, black, black, brown, brown	<input type="checkbox"/>
R16	1k	Brown, black, black, brown, brown	<input type="checkbox"/>
R23	1k	Brown, black, black, brown, brown	<input type="checkbox"/>
R1	22k	Red, red, black, red, brown	<input type="checkbox"/>
R15	22k	Red, red, black, red, brown	<input type="checkbox"/>
R13	27K	Red, violet, black, red, brown	<input type="checkbox"/>
R26	27K	Red, violet, black, red, brown	<input type="checkbox"/>
R5	30K1	Orange, black, brown, red, brown	<input type="checkbox"/>
R18	30K1	Orange, black, brown, red, brown	<input type="checkbox"/>
R6	3320	Orange, orange, red, brown, brown	<input type="checkbox"/>
R7	3320	Orange, orange, red, brown, brown	<input type="checkbox"/>
R19	3320	Orange, orange, red, brown, brown	<input type="checkbox"/>
R20	3320	Orange, orange, red, brown, brown	<input type="checkbox"/>
R11	47k5	Yellow, violet, green, red, brown	<input type="checkbox"/>
R12	47k5	Yellow, violet, green, red, brown	<input type="checkbox"/>
R24	47k5	Yellow, violet, green, red, brown	<input type="checkbox"/>
R25	47k5	Yellow, violet, green, red, brown	<input type="checkbox"/>
R8	5900	Green, white, black, brown, brown	<input type="checkbox"/>
R21	5900	Green, white, black, brown, brown	<input type="checkbox"/>
R9	75K0	Violet, green, black, red, brown	<input type="checkbox"/>
R22	75K0	Violet, green, black, red, brown	<input type="checkbox"/>

Now you'll install the non-polarized capacitors. We start with the smallest capacitors, and work toward the larger capacitor values. These capacitors are not orientation sensitive.

Desig	Value	Marking	Done <input checked="" type="checkbox"/>
C12	100 pF	101, axial	<input type="checkbox"/>
C25	100 pF	101, axial	<input type="checkbox"/>
C5	220 pF	221, axial	<input type="checkbox"/>
C18	220 pF	221, axial	<input type="checkbox"/>
C6	680 pF	681, axial	<input type="checkbox"/>
C19	680 pF	681, axial	<input type="checkbox"/>
C13	2.7 nF	272, blue ceramic radial cap	<input type="checkbox"/>
C26	2.7 nF	272, blue ceramic radial cap	<input type="checkbox"/>
C2	10 nF	10nF1K0	<input type="checkbox"/>
C15	10 nF	10nF1K0	<input type="checkbox"/>
C1	47 nF	47n F 630	<input type="checkbox"/>
C14	47 nF	47n F 630	<input type="checkbox"/>
C10	0.1 μ F	μ 1J100	<input type="checkbox"/>
C11	0.1 μ F	μ 1J100	<input type="checkbox"/>
C23	0.1 μ F	μ 1J100	<input type="checkbox"/>
C24	0.1 μ F	μ 1J100	<input type="checkbox"/>
C3	0.33 μ F	0.33J63	<input type="checkbox"/>
C4	0.33 μ F	0.33J63	<input type="checkbox"/>
C16	0.33 μ F	0.33J63	<input type="checkbox"/>
C17	0.33 μ F	0.33J63	<input type="checkbox"/>
C9	3.3 μ F	3.3k63	<input type="checkbox"/>
C22	3.3 μ F	3.3k63	<input type="checkbox"/>

The following capacitors are electrolytic capacitors. ***The polarity is important. Be sure to look at the polarity as marked on the silk screen, and make it agree with the capacitor markings.*** Note that the 47 μ F capacitor foot print doesn't quite match the PCB, but it installs reasonably well.

Desig	Value	Marking	Done <input checked="" type="checkbox"/>
C7	47 μ F, 25V or 50V in Rev C	See the value column	<input type="checkbox"/>
C20	47 μ F, 25V or 50V in Rev C	See the value column	<input type="checkbox"/>
C27	47 μ F, 25V or 50V in Rev C	See the value column	<input type="checkbox"/>
C8	1000 μ F, 10V	See the value column	<input type="checkbox"/>
C21	1000 μ F, 10 V	See the value column	<input type="checkbox"/>

Match the shape of the transistor body to the shape of the silk-screen. Leave about 3/8" of space between the bottom of the transistor package and the PCB. Don't get too much heat onto the transistors.

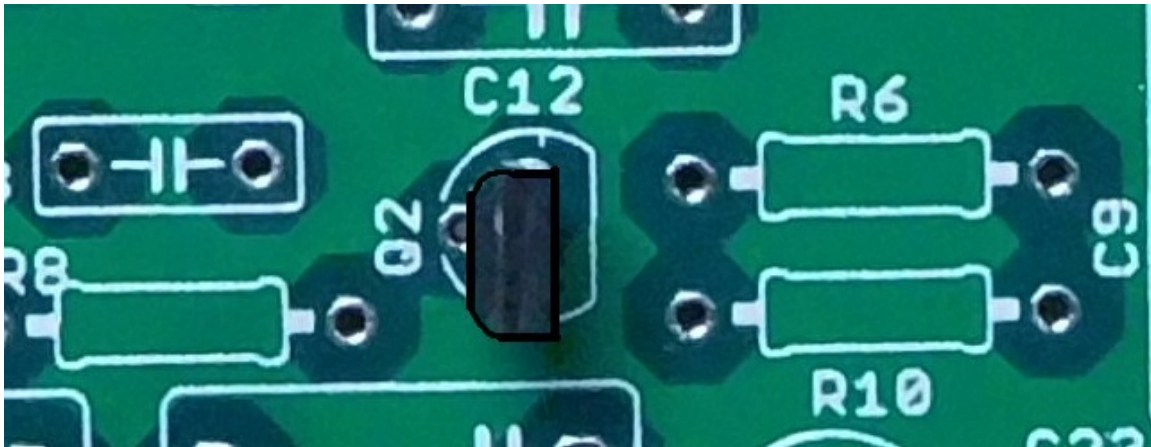

Figure 3-Orientation of the BCX38C transistor

Desig	Value	Marking	Done <input checked="" type="checkbox"/>
Q1	MPSA18, high gain NPN	MPSA18	<input type="checkbox"/>
Q3	MPSA18, high gain NPN	MPSA18	<input type="checkbox"/>
Q2	BCX38C, Darlington NPN	BCX38C	<input type="checkbox"/>
Q4	BCX38C, Darlington NPN	BCX38C	<input type="checkbox"/>

Prepare and Add Shielded Cables to the Inputs

For lowest hum, you must use shielded cable between the PHONO LOW RCA Jacks and the inputs on the PCB. Prepare two 4" lengths of shielded cable:

1. One for the right channel, using the red conductor and the drain wire.
2. One for the left channel, using the black conductor and the drain wire.

Details on the preparation of the shielded cables can be found in Appendix 2 - Preparing a Shielded Cable End. Prepare both ends of both pieces of shielded cable now, as it will make it much easier to later complete installation of the input wiring.

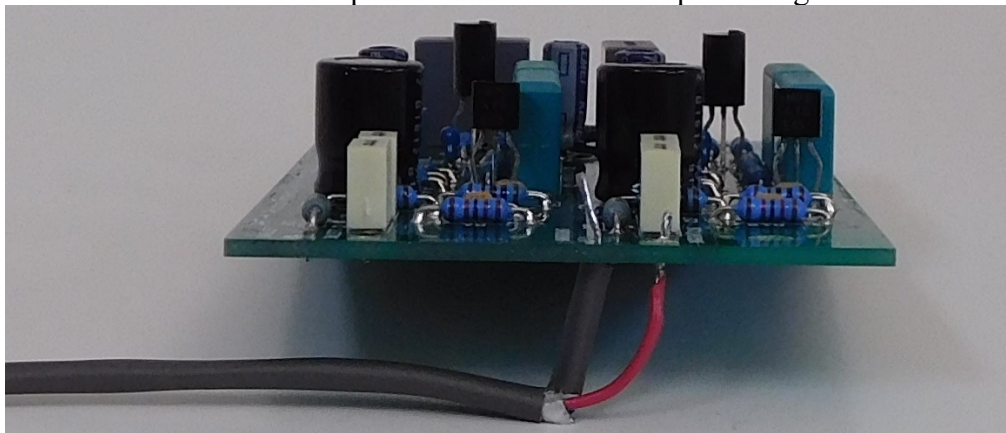

Figure 4-Shielded cable installation (right channel shown here)

Connect the wires as follows:

1. Right channel signal wire (red) to the eyelet labeled INRIGHT
2. Right channel drain wire (bare wire covered with added gray outer jacket) to the eyelet labeled GNDRIGHT.
3. Left channel signal wire (black) to the eyelet labeled INLEFT
4. Left channel drain wire (bare wire covered with added gray outer jacket) to the eyelet labeled GNDLEFT.

Double check that you have not reversed the ground and signal wires.

Install the Mounting Brackets

Use 6-32x1/4" sems screws to install mounting brackets as shown in Figure 5. Make sure the brackets are straight before you tighten them.

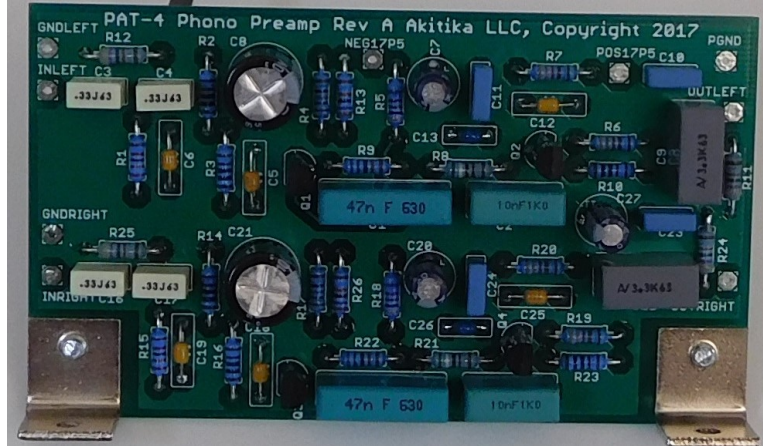

Figure 5-Use 6-32x1/4" screws to attach mounting brackets

Preparing to Install the Assembled PAT4PPR Circuit Board

1. Disconnect the PAT-4 from your music system.
2. Unplug the power cord and allow the preamp to sit for one minute before moving on.

Caution: Be sure that the preamp power is unplugged! 120 VAC can be lethal! 240 VAC can be lethal!

3. Remove the 4 screws that hold the cover in place, 2 on the left side and 2 on the right side.
4. Lift the cover straight up and set it aside in a safe place.

Drilling Mounting Holes in the PAT-4 Chassis

You'll need to add two 9/64" mounting holes to the PAT-4 chassis. 5/32" holes are also ok, and may give you a bit more margin if you drill slips a bit. It's a good idea to use a center-punch to locate the centers of the two mounting holes. Without the center-punch, the drill will tend to drift off the mark.



Figure 6-Locating the mounting holes

Locate the drill holes near the selector switch as follows:

1. The front mounting hole should be on a line with the front hole that holds the cover. The center of the hole should be 0.250" from the inside lip of the chassis so that the end of the bracket won't bump into the lip of the chassis.

- The rear mounting hole is also placed 0.25" from the inside lip of the chassis, but it is located 3.400" behind the front mounting hole.
not to scale

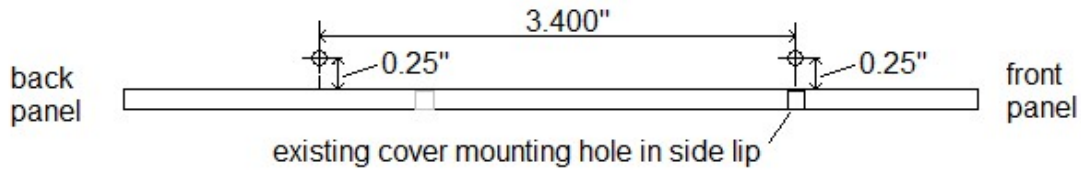

Figure 7-locating the two added 9/64" mounting holes

An easy way to locate the holes is to sit the PCB with mounting brackets (make sure they're on straight) in the intended location, then mark the hole locations with a pencil or a center-punch.

Connect the RCA Jacks

Remove the PEC 555005. It is no longer needed. Please note that the PHONO HIGH and PHONO CER jacks will no longer be active.

De-solder or cut any existing wires on the center terminals of either the right or left channel PHONO LOW input jacks.

Make the following connections between the shielded cables and the RCA jacks:

- Right channel signal conductor (red) to center of right channel RCA jack.
- Right channel ground conductor (drain wire covered with a bit of reserved gray jacket insulation) to the ground lug of the right channel RCA jack.
- Left channel signal conductor (black) to center of left channel RCA jack.
- Left channel ground conductor (drain wire covered with a bit of reserved gray jacket insulation) to the ground lug of the left channel RCA jack.

For both the right and left channels, connect a 0.01 μF 400 V² capacitor between the chassis ground lug and the RCA ground lug. Figure 8 shows this connection for the left channel. The right channel is connected similarly. Note that the white wire shown connects to the jack-field grounds (or the associated RCA jack lugs) and pin 5 of the selector switch. Also note: your 0.01 μF cap may look different than the one pictured.



Figure 8-Connecting Left Channel input jack and 0.01 μF capacitor

² Recent kits supply 0.01 μF (10 nF) 100 volt capacitors, box shaped, blue in color.

Move Power Wires

At this point, +17.5 V, -17.5 Volt power and ground wires run from the PAT4PWR board to the phono section of the original preamp PCBs. We will instead run those power wires to the new PCB.

- Clip or de-solder the wires currently going to eyelets 3, 4, and 8 of the original PCB closest to the front panel.
- Clip or de-solder the wires currently going to eyelets 3, 4, and 8 of the original PCB closest to the rear panel.
- De-solder the far-ends of the wires just removed from their connections to the PAT4PWR board. Clear the associated holes on the PAT4PWR board using your preferred method (for example, the toothpick trick).
- A note about the wires in eyelet 8:
 - If you previously had installed the PAT4LP kit, the wires in eyelet 8 will connect to the negative 17P5 terminal of the PAT4PWR module.
 - If you had not previously installed the PAT4LP kit, then the wires from eyelet 8 will go to the selector switch. In this case, clip the wire at both the PCB side and the selector switch side and remove it.
- Form a twisted pair from the supplied red and black 22 AWG wires. Connect:
 - Red wire to the P17P5 eyelet of the PAT4PWR
 - Black wire to the associated GND eyelet
 - The other end of the Red wire to the POS17P5 eyelet of the new phono preamp.
 - The other end of the black wire to the PGND eyelet of the new phono preamp.
- Connect a purple 22 AWG wire from the N17P5 eyelet of the PAT4PWR board to the NEG17P5 eyelet of the new phono preamp.

Move Selector Switch Wires

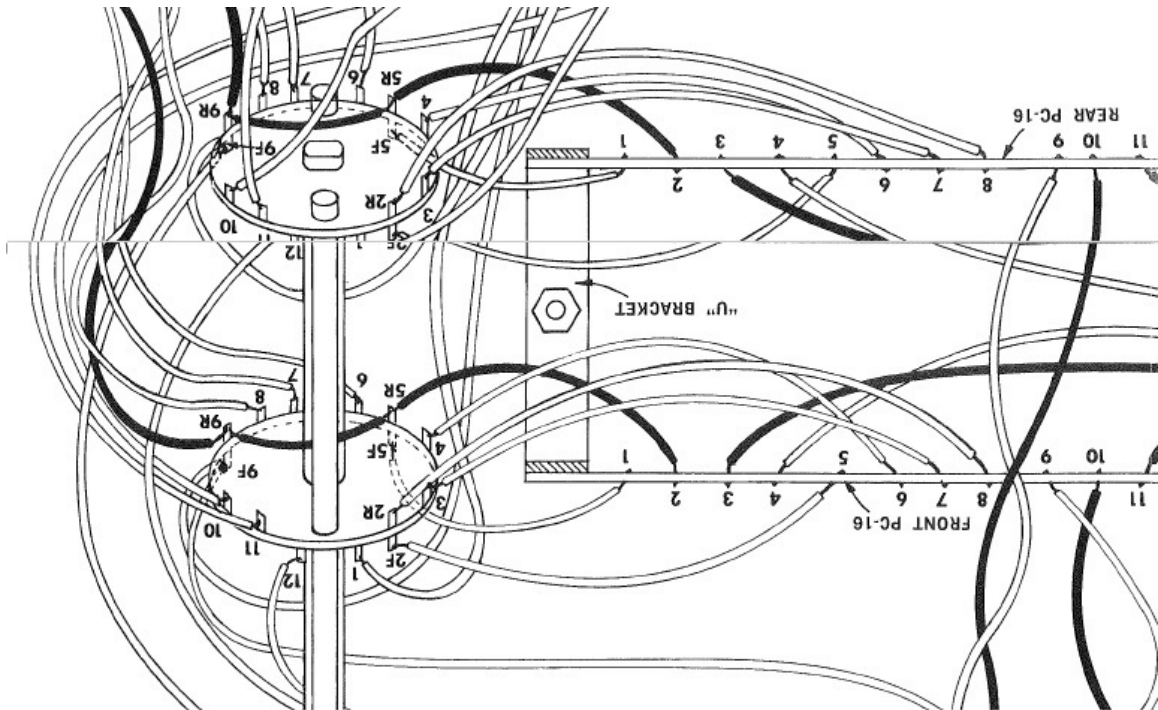

Figure 9-Selector Switch wire identification

Now we'll move the selector switch wires to select the output of the new phono preamp when the selector switch is in the PHONO position.

1. Identify the wire that connects to terminal 8 of the front deck of the selector switch. De-solder the opposite end of that wire from its current location.
 - a. If your PAT-4 phono section was stock, that end was connected to the center terminal of the right channel PHONO LOW RCA jack.
 - b. If your PAT-4 phono section was upgraded with the PAT4LP, that end was connected to eyelet 5 of the front preamp PCB.
2. Re-attach the end of that wire to the OUTRIGHT eyelet of the new PCB. Cut it to a reasonable length. Insert the wire from the solder side, and solder it on the component side.
3. Identify the wire that connects to terminal 8 of the rear deck of the selector switch. De-solder the opposite end of that wire from its current location.
 - a. If your PAT-4 phono section was stock, that end was connected to the center terminal of the left channel PHONO LOW RCA jack.
 - b. If your PAT-4 phono section was upgraded with the PAT4LP, that end was connected to eyelet 5 of the rear preamp PCB.
4. Re-attach that wire to the OUTLEFT eyelet of the new PCB. Cut it to a reasonable length. Insert the wire from the solder side, and solder it on the component side.

Converting to Accept 5 high level inputs and 1 phono input

These modifications will give you 5 high level inputs and 1 phono input. After performing these modifications, TAPE HEAD and SPECIAL will both accept normal high level inputs.

Ground Changes, refer to Figure 10.	Done ✓
Desolder the ground wire from FRONT PC-16, eyelet 2. Cover the bare portion with electrical tape, but leave it connected to the switch.	<input type="checkbox"/>
Desolder the ground wire from REAR PC-16, eyelet 2. Cover the bare portion with electrical tape but leave it connected to the switch.	<input type="checkbox"/>
Remove the following ground wires at the rear panel: <ul style="list-style-type: none"> a. Short Lug 2-3 to Short Lug 4-5 b. Short Lug 13-14 to Short Lug 15-16 	
Add the following ground wires at the rear panel: <ul style="list-style-type: none"> a. Short Lug 4-5 to Short Lug 6-7 b. Short Lug 15-16 to Short Lug 17-18 	

Selector Switch Wiring Changes, refer to Figure 9.	Done ✓
Identify the wire that connects to terminal 5F of the front deck of the selector switch. De-solder its far end (it will typically be connected to eyelet 1 of the front PC-16).	<input type="checkbox"/>
Identify the wire that connects to terminal 2F of the front deck of the selector switch. De-solder its far end (it will typically be connected to eyelet 5 of the front PC-16).	<input type="checkbox"/>
Twist the above two wires together, solder, and tape the connection. The effect of this is to connect together front-deck selector switch terminals 2F and 5F.	<input type="checkbox"/>
Identify the wire that connects to terminal 5F of the rear deck of the selector switch. De-solder its far end (it will typically be connected to eyelet 1 of the rear PC-16).	<input type="checkbox"/>
Identify the wire that connects to terminal 2F of the rear deck of the selector switch. De-solder its far end (it will typically be connected to eyelet 5 of the rear PC-16).	<input type="checkbox"/>
Twist the above two wires together, solder, and tape the connection. The effect of this is to connect together rear-deck selector switch terminals 2F and 5F.	<input type="checkbox"/>

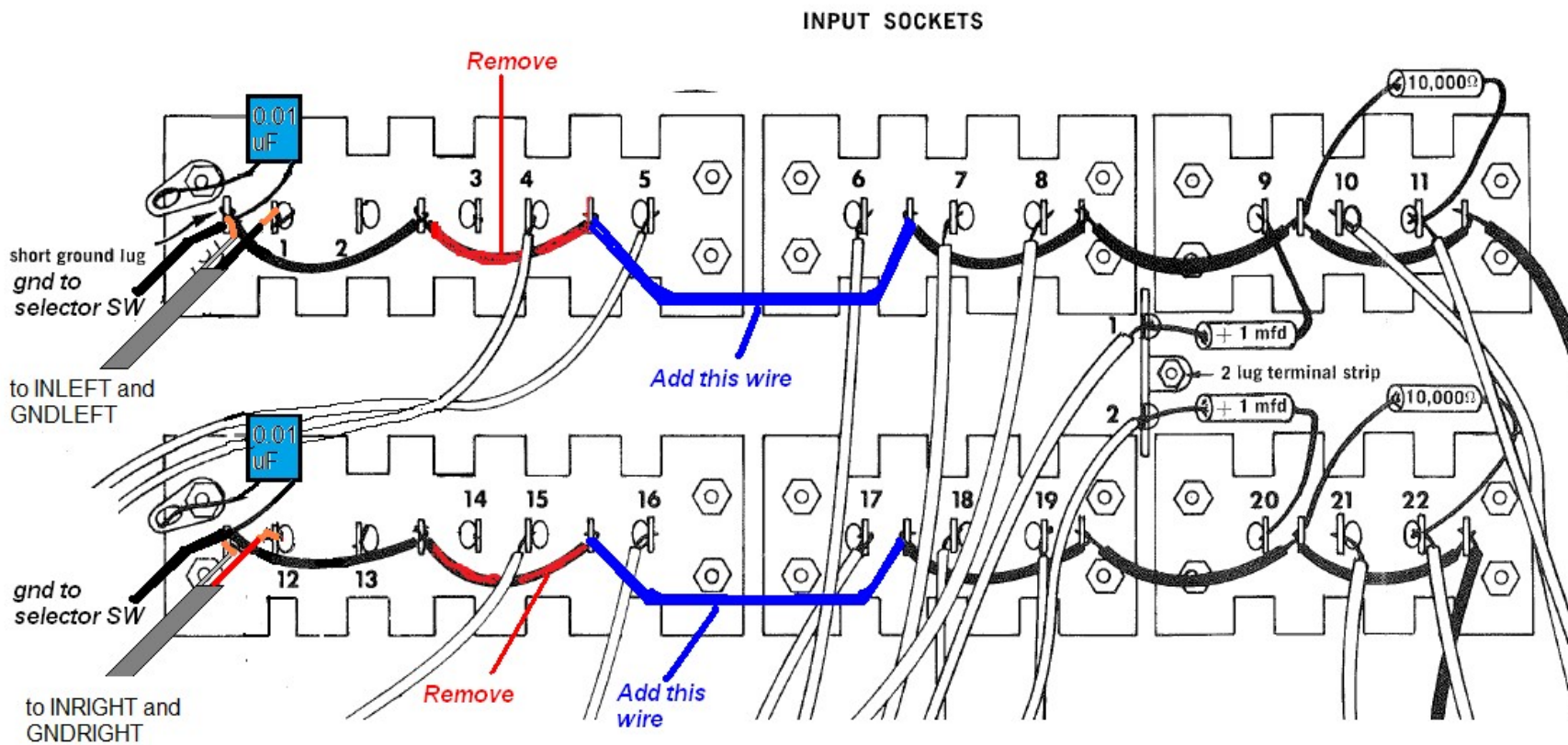

Figure 10-Back Panel Re-wiring

Inspection and Preliminary Reassembly

Inspect your work for good solder joints and freedom from solder bridges. Touch up any questionable connections now.

Install the phono preamp adjacent to the selector switch using 6-32x1/4" screws and the holes you drilled in an earlier step. You may have to finesse the existing wires on the selector switch, but the new phono preamp PCB will slide in there nicely.

Final Sanity Checks

Here are a few last tests before you reconnect your PAT-4 to your music system. With the top still off, plug in the AC mains. Turn on the power switch. Set your meter to DC volts. Connect one lead of the meter to ground.

<i>Be careful! These steps are performed with the power connected and turned on!</i>	Done ✓	Done ✓
The voltage on the NEG17P5 terminal of the new phono preamp should measure between -17 and -18 Volts DC (with respect to ground).	<input type="checkbox"/>	<input type="checkbox"/>
The voltage on the POS17P5 terminal of the new phono preamp should measure between 17 and 18 Volts DC (with respect to ground).	<input type="checkbox"/>	<input type="checkbox"/>
The voltage on eyelet 12 of both original preamp PCB's should measure between 36 and 40 volts DC (with respect to ground).	<input type="checkbox"/>	<input type="checkbox"/>

Prepare to Reconnect your PAT-4 to your Music System

- Turn off the power.
- Remove the AC plug from the wall socket.
- Replace the cover.
- Reinstall the four screws that hold the cover in place.
- Reinstall the PAT-4 to your music system.
- Notes:
 - Use the PHONO LOW input for your turntable. The other two PHONO inputs, PHONO HIGH and PHONO CER are disconnected.
 - Given the 5 high-level and one phono wiring, then:
 - The TAPE HEAD input is a high-level input
 - The SPECIAL input is a high-level input

Record Playing Reminders

If it has been a while since you've played records here are a few hints that you may find useful.

- The ground wire between the turntable and the ground screw on the back-panel of the PAT-4 preamp must be connected to minimize the hum. Usually, that wire runs loosely along with the RCA cords.
- Check your tracking force and anti-skating force. Re-balance your tone arm if it has been a while.

- Make sure that the grounding crown of the RCA plugs fit snugly around the grounds of on the preamp inputs. A good connection is important for low noise performance.
- Watch for acoustic feedback that can arise if the speakers are too close to the turntable. Increasing the space between the speakers and the turntable will help.
- The signal to noise ratio (SNR) of a record isn't what you're used to with digital, it's less. Still, the music on the records mostly masks the noise, except in soft portions, or if the record is worn or dirty.
- Is one channel out? Swap phono outputs and preamp inputs to get to the bottom of the problem. This will let you figure out if it's a turntable/cartridge problem or a preamp problem.
- A frequent source of "one channel out" problems in the turntable/cartridge system comes from bad connections between the wires in the head-shell and the phono cartridge. The push-on connectors become flakey. If this is the issue, you can often renew the connection by carefully rotating the push-on connector on the cartridge's input pin:
 - Be careful not to bump the stylus or cantilever.
 - Hold the cartridge body in one hand.
 - Rotate the push-on connectors around the input pin using needle nose pliers. This will clean the crud, and also let you tell if the connections are so loose as to also cause a problem.
- Need more information on your old turntable? Visit www.vinylengine.com . They have an extensive collection of turntable service manuals.
- Why Vinyl? Because it seems to have a higher SAR (Soul to Annoying Artifacts Ratio) than most digital.

Gain Tweaks

I think you'll find that the phono preamp has just the right amount of gain for you, which will put the PAT-4 volume control at a nice play when you play LP's. However, if you find that the phono preamp has too much gain for your setup (cartridge and power-amp), you can drop it by up to 6 dB by increasing the value of both R4 and R17 to 300 Ohms. Be sure to use a high-quality metal film resistor.

More Tweaks

The design is unique in that the collector resistor (R6 and R19) in the output stage can be made as low as 1K Ohm (even lower, actually) with no other adjustments to the phono preamp. However, you will need to change the power supply to assure that you have adequate current available. The advantage of lowering this resistor is the availability of more current to drive the feedback network, further lowering distortion below the already low numbers.

Schematics

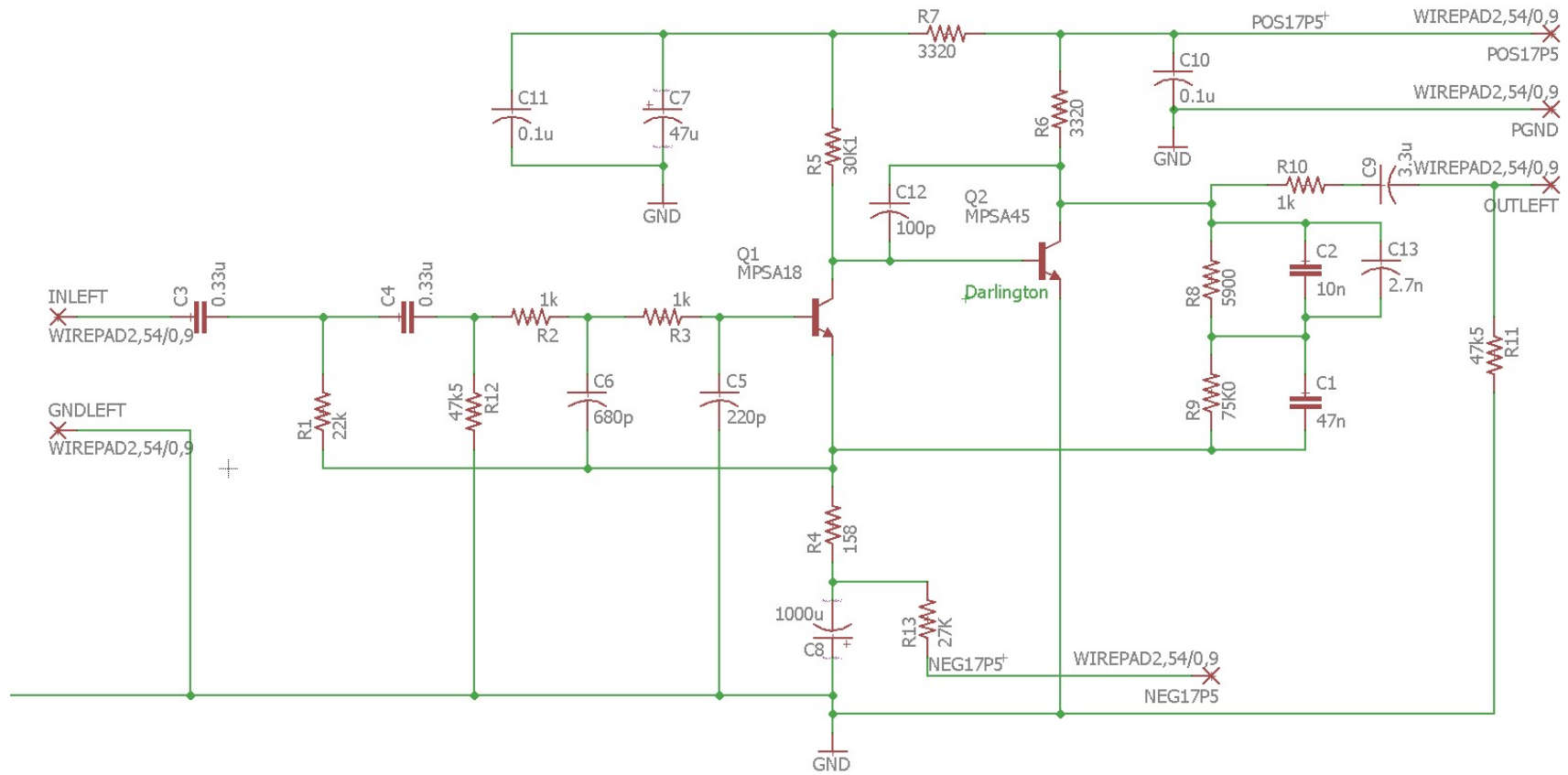

Q2 is a BCX38C in Rev D
Figure 11-Phono Preamp Schematic Page 1

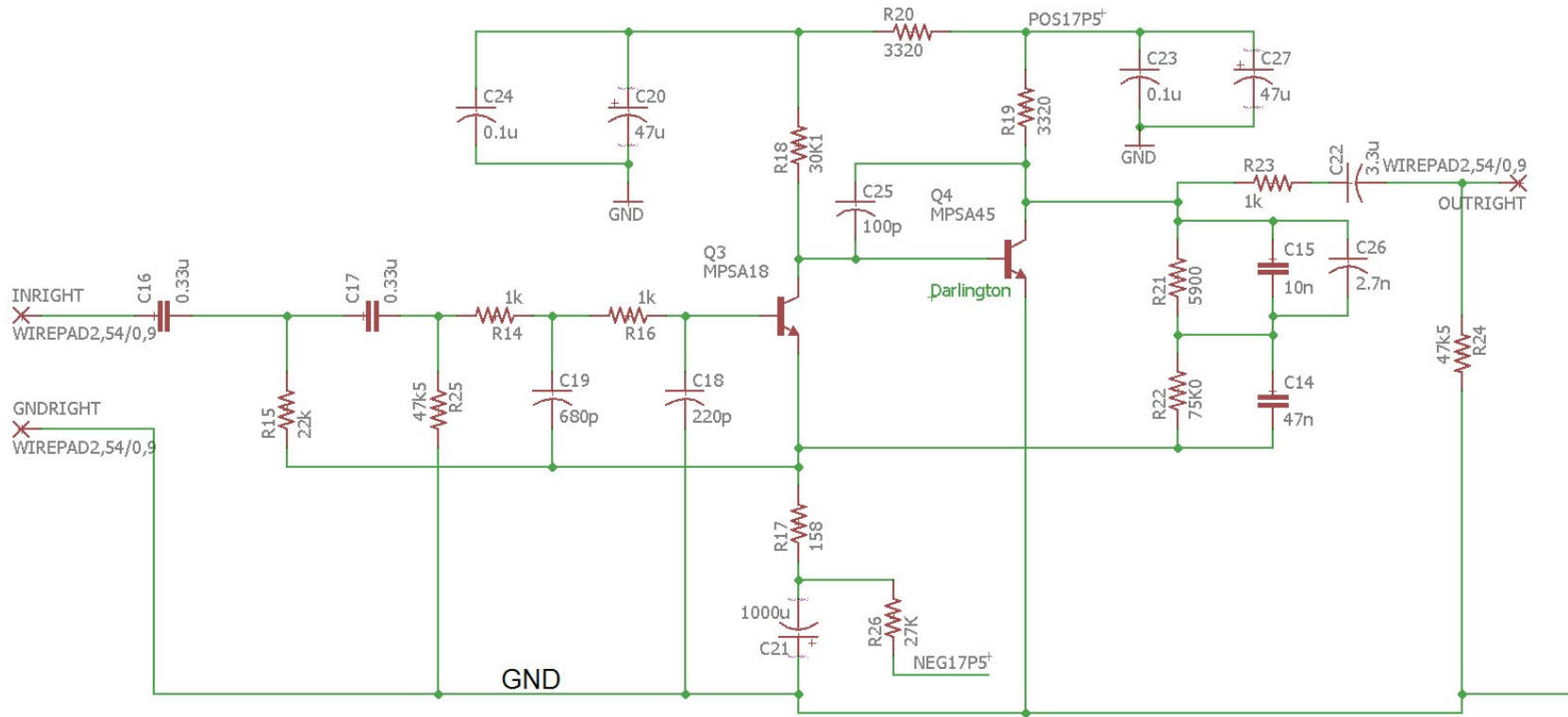

Q4 is a BCX38C in Rev D
Figure 12-Phono Preamp Schematic Page 2

Specifications

Frequency response – typically within a 0.5 dB error band between 20 Hz and 20 kHz, with the exception that the response is -0.5 dB at 20 Hz in support of the high pass filter.

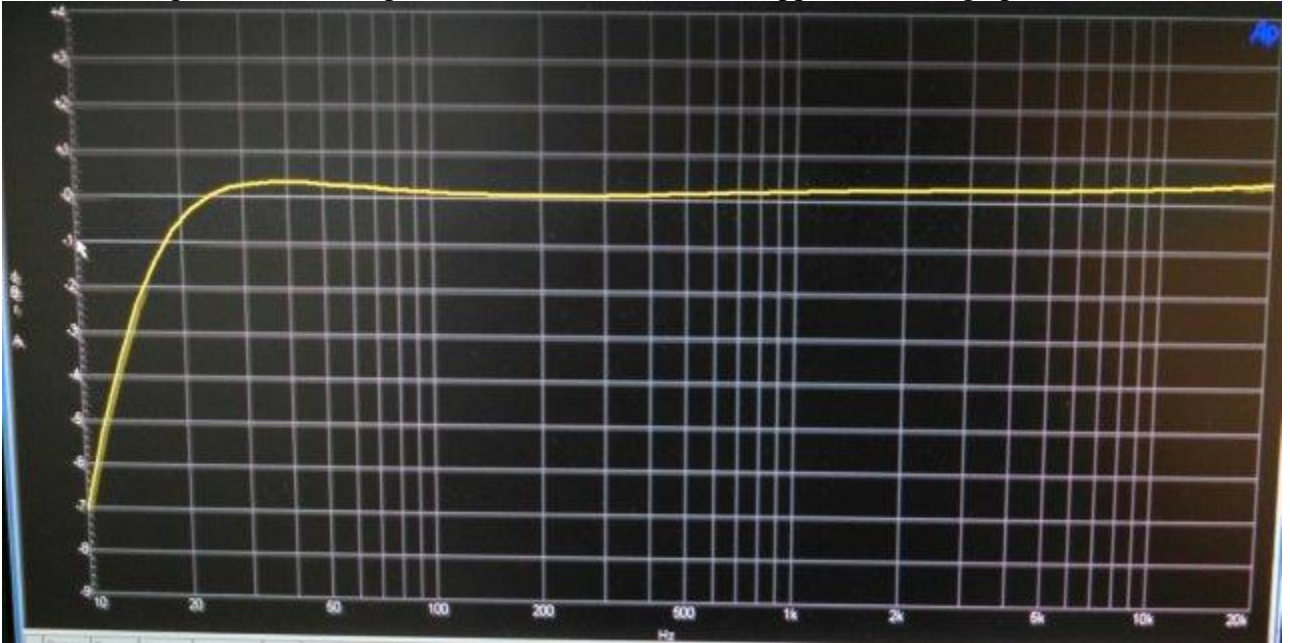

High Pass Filter (with respect to 1 kHz)

- -0.7 dB at 20 Hz
- -7.4 dB at 10 Hz
- -19 dB at 5 Hz

Low Pass Filter (with respect to 1 kHz)

- -0.5 dB at 20 kHz
- -4.4 dB at 100 kHz
- -10 dB at 500 kHz
- -22 dB at 1 MHz

Gain at 1 kHz – 33.4 dB

Distortion

- 5 mV rms input at 1 kHz produces 230 mV RMS with only 2nd harmonic, which is -87 dB (0.0044% distortion)
- 10 mV rms input at 1 kHz produces 460 mV RMS with only 2nd harmonic, which is -80 dB (0.01% distortion)
- 40 mV rms input at 1 kHz produces 1.84 Volts RMS with just 0.044% distortion. 40 mV is probably 4 times as much as will ever come out of your phono cartridge.

Appendix 1: The Toothpick Trick

This appendix describes an easy way to clear the solder from a hole in the PCB. It can also be used to clear the solder from terminals on pots or jacks. Doing so makes it easier to install a new component, or reinstall wires that were temporarily removed to allow access to some other component.

All you'll need is a soldering iron and some toothpicks with sharp points. The diameter of the pointed part of the toothpick must be smaller than the diameter of the hole that you're trying to clear.

Heat the solder land on the component side of the board until the solder flows. Insert the toothpick from the component side of the board while pushing and twisting the toothpick. If the solder has melted, the toothpick should push through the board, displacing the solder. Remove the soldering iron, but let the toothpick remain in the hole until the solder has solidified. Now remove the toothpick. There should be a hole through the solder sufficiently large to allow you to insert the component lead or wire.

Sometimes, a bit of the toothpick will break off in the hole. If this happens, use a stiff piece of wire to push the toothpick fragment out of the hole.

Appendix 2 - Preparing a Shielded Cable End

This section tells how to prepare the ends of the shielded cable. This process will be repeated four times, at both ends of both input cables (although the cables will have different overall lengths).

1. Cut the shielded cable to the overall required length.



2. Use a utility knife with a new, sharp blade to cut the plastic jacket of the shielded cable 3/4" back from the end. Hold the blade perpendicular to the cable, and draw it across the cable lightly as you rotate the cable along its long dimension. This creates a scored line through the plastic jacket. With a sharp blade, not much pressure is needed. You may need a bit of practice to get the feel.



3. If you've scored the jacket carefully, you can separate the jacket at the score line without using tools. Pull the insulating jacket off, exposing the cable, showing the foil shield, the drain wire, and the fuzzy string. The result is shown here, with the foil shield showing.



4. Cut off the fuzzy string.



5. Separate and twist the drain wire.

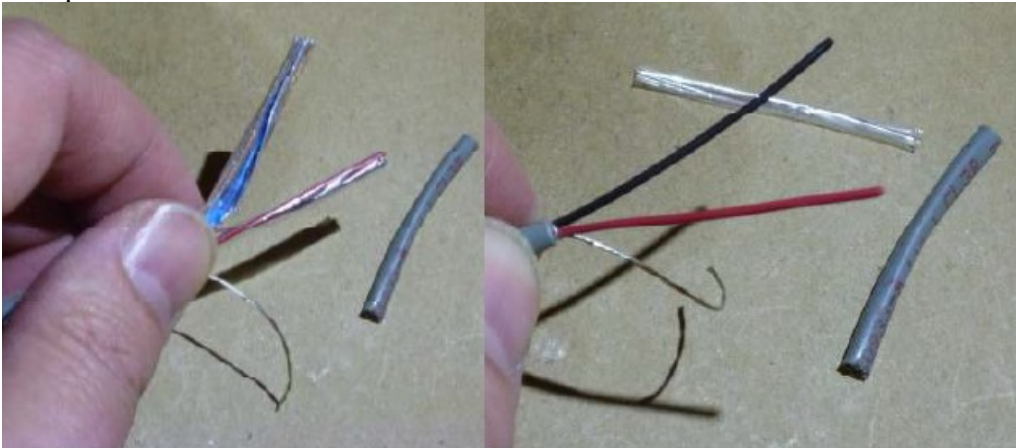

6. Peel back and remove the foil. Remove the plastic wrap from the red and black wires. The drain (bare wire), red, and black wires are exposed now that gray insulating jacket, foil shield, and plastic over-wrap have been removed.
7. To make a shielded cable for a right channel application, pull the black wire out of the shielded cable and leave the red wire for RIGHT channel signals.
8. To make a shielded cable for a LEFT channel application, pull the red wire out of the shielded cable and leave the black wire for LEFT channel signals.
9. Remove 1/4" of insulation from the red wire. Twist its strands tightly. Twist and tin the ends of the red wire (or black wire if preparing a left channel input cable) and the drain wire.
10. Slip about half of the gray outer jacket you removed in the first step over the drain wire. This will keep the bare drain wire from contacting something by accident.

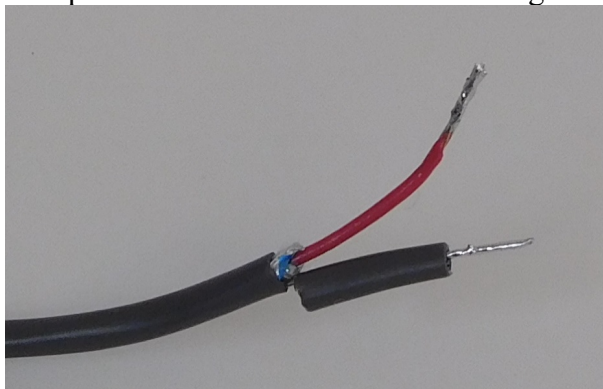

Figure 13- Shield wire end prep completed (right channel)

Appendix 3 - Resistor Color Code



Figure 14-demonstrating the resistor color code

Here's an extreme close-up of a ¼ W metal film 20K (20,000) Ohm resistor, designated by the standard resistor color code.

The colors map to numbers:

Color	Number
Black	0
Brown	1
Red	2
Orange	3
Yellow	4
Green	5
Blue	6
Violet	7
Gray	8
White	9

The color band positions have the following meaning:

Position	Meaning
1	Left-most Digit (e.g. most significant)
2	Next digit to the right
3	Next digit to the right.
4	Number of zeros that follow the three digits, unless: <ul style="list-style-type: none"> • Band 4 is gold => multiply by 0.1 • Band 4 is silver=> multiply by 0.01
5	Tolerance: <ul style="list-style-type: none"> • Violet => 0.1% • Brown =>1% • Red => 2% • Gold=> 5% • Silver=>10%