

# ***dynaco***

## **STEREO 150**

SERIAL NUMBER

This number must be mentioned in all communications concerning this equipment.

# **INSTRUCTIONS FOR ASSEMBLY OPERATION**



462-000007-000

***dynaco inc.***

COLES ROAD & CAMDEN AVENUE / POST OFFICE BOX 88  
BLACKWOOD, N. J. 08012, U.S.A.

## CONTENTS

Specifications .....	2	Circuit Description .....	11
Introduction .....	3	Block Diagram .....	11
Installation .....	3	Schematic Diagram .....	12
Connections .....	3	Component Values .....	13
Operation .....	4	In Case of Difficulty .....	20
Assembly Instructions .....	5	Meter Option .....	20
Mechanical Assembly .....	7	Voltages .....	20-21
Wiring the Heat Sink .....		Circuit Board Layouts .....	20-21
and PC-36 .....	9	240 Volt Wiring .....	22
Power Supply Board Wiring .....	15	Service Policy and Limited Warranty .....	23
Final Assembly .....	17	Kit Parts List .....	24
		Pictorial Diagram .....	Insert

## SPECIFICATIONS

### Power output ratings:

Less than 0.25% total harmonic distortion at any power level up to 75 watts continuous average power per channel into 8 ohms (40 watts per channel into 16 ohms, or 150 watts monophonically into 8 ohms) at any frequency between 20 Hz and 20 kHz with both channels driven. Distortion reduces at lower levels.

### Available power output:

(See above for F.T.C. Power Ratings)

20 Hz to 20 kHz, both channels driven:

- 75 watts continuous average per channel @ 8 ohms;
- 100 watts continuous average per channel @ 4 ohms,\*
- 40 watts continuous average per channel @ 16 ohms.

Monophonically, 20 Hz to 20 kHz:

- 150 watts continuous average @ 8 ohms.

\* 4 minute sustained full power limit without a fan.

### Intermodulation distortion:

Less than 0.25% at any power level up to 75 watts rms per channel into 8 ohms with any combination of test frequencies. Distortion reduces at lower power levels.

### Power at clipping, single channel, 2500 Hz, less than 1% distortion:

- 90 watts @ 8 ohms;
- 130 watts @ 4 ohms;
- 45 watts @ 16 ohms.

### Half-power bandwidth:

37.5 watts per channel at less than 0.25% total harmonic distortion from 5 Hz to 40 kHz into 8 ohms.

### Frequency response:

+0, -1 dB, 10 Hz— 40 kHz @ 1 watt into 8 ohms;  
±0.5 dB, 20 Hz— 20 kHz @ 75 watts.

### Hum and noise:

Greater than 95 dB below rated output, full spectrum.

### Input:

35,000 ohm load; 1.0 volt for 75 watts @ 8 ohms.

### Slewing rate:

5 volts per microsecond.

### Damping factor:

Greater than 80 to 1 kHz into 8 ohms;  
Greater than 50 to 10 kHz into 8 ohms.

### Channel separation:

Greater than 70 dB by IHF standards.

### Connectors:

Inputs: phono jacks. Outputs: Color coded 3-way binding posts with standard 3/4" spacing.

### Dimensions:

14 1/2" wide, 13 3/4" deep, 6 5/8" high.

### Weight:

Shipping weight 34 lbs; Net weight 29 lbs.

### Power consumption:

60 v.a. quiescent; 5 amps maximum; 50/60 Hz, 120/240 vAC.

## TYPICAL PERFORMANCE CURVES

To arrive at "typical" curves, four channels were evaluated on all bases. In each case, the curve shown is the next-to-the-worst of the four. Therefore, do not expect exact correlation between curves.

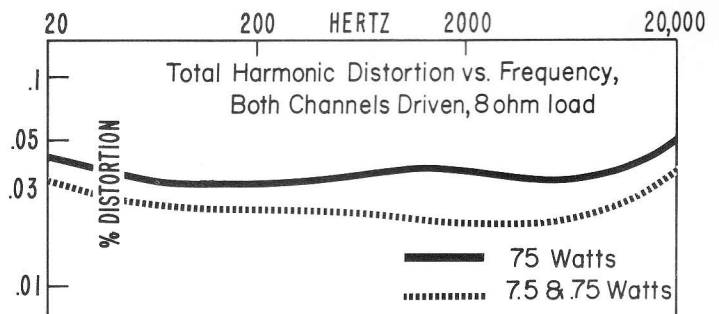
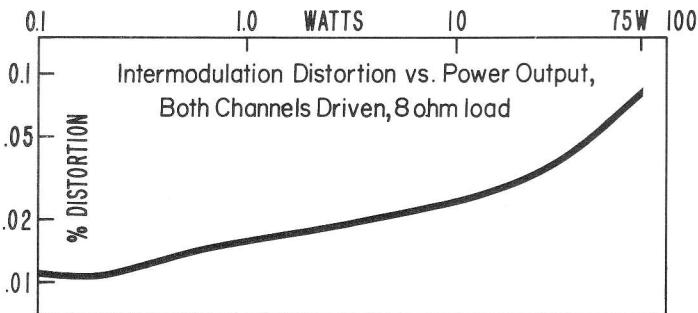

## INTRODUCTION

The Dynaco Stereo 150 is a basic two channel power amplifier employing all silicon semiconductors. They include 24 transistors, 2 zener diodes, 16 diodes, and 2 thermal sensors. The output circuitry is of the full complementary symmetry design. The entire amplifier, except for an input network, is direct coupled. Its measured distortion levels approach the threshold of much laboratory test equipment, not only at the commonly specified full power ratings, but more importantly at very low power outputs as well. This is the result of circuit techniques which eliminate any discernible crossover notch at low levels, and contributes to the Stereo 150's freedom from listening fatigue. Its accurate, uncolored sonics have been achieved on a wide variety of loudspeaker loads, including electrostatics and multiple drivers with complex crossovers.

The design of a very fine power amplifier implies the necessity of several protection techniques for the amplifier, and for the speaker load. In addition to the AC line fuse,

four separate B+ fuses are supplied. Electronic volt-amp limiting ensures safe operation of the output transistors, and a thermal sensor mounted directly on each output stage reduces the *input* if high temperature occurs. An unusually large radiating area for the heat fins, which are coupled to an aluminum back panel, form a highly efficient heat sink. Speaker fuses protect the load.

The Stereo 150 has been designed as two independent 75 watts (at 8 ohms) amplifying channels with a common power supply having a high degree of inherent regulation. In addition, where higher powers or higher volt-amp capabilities are required for lower load impedances, easy internal restrapping permits monophonic operation for 150 watts output (at 8 ohms).

An accessory kit is planned at additional cost for two output meters and meter switching, which includes alternative inserts for the front panel. It will be available in late 1975.

## INSTALLATION

The Stereo 150 may be located in view or out of sight, since it will usually be controlled by a separate preamplifier, whose power switch will be used to turn the amplifier on and off. If the amplifier is to be mounted near a phonograph cartridge, check to make sure the cartridge does not pick up hum from the power transformer. Nothing should be placed on the perforated portion of the top of the amplifier. In addition to the finned heat sink, it is normal for the top to get rather warm when delivering high power output, particularly above the perforated metal.

VENTILATION is an important consideration. Although solid state units do not generate the high heat expected from tube designs, they can be limited by excessive heat buildup. All solid state amplifiers generate very nearly the same heat at 10% as they do at 100% power output, and maximum heat is generated at about 40% of full power. Thus, ADEQUATE AIR CIRCULATION IS ESSENTIAL. The Stereo 150 puts out the heat of a 40 watt lamp under

quiescent (no signal) conditions, and several hundred watts of heat at high power levels. The large, very efficient heat sink has more than enough cooling capacity for any music and speech signals—even at high powers—if fresh air flow under and around the unit is not restricted. Otherwise, fan cooling is suggested.

The Stereo 150 is intended to be installed horizontally, with its feet providing clearance for air flow under the unit. Do not allow the ventilation slots in the bottom to be restricted (don't place the amplifier on a rug, for example). The amplifier should not be mounted vertically, unless it is fan-cooled, and DO NOT TRY TO SUPPORT THE UNIT BY THE FRONT PLATE.

If you wish to mount the amplifier through a cabinet panel, a cutout 6" x 13<sup>5</sup>/<sub>8</sub>" is suggested. Remove the feet for front mounting access. A support flush with the bottom of the cutout should include an opening for the chassis vents.

## CONNECTIONS

### INPUT

Signal inputs are connected by shielded cables to conventional phono jacks on the back panel, under the heat sink. Channel A is designated the left channel; B the right. The amplifier's nominal input load impedance is 35,000 ohms. The input sensitivity is 1.0 volt for full output. The Stereo 150 may thus be easily driven by control preamplifiers such as the Dynaco PAT-5, PAT-4 or PAS-3X. The Dynaco PAS-3X tube type preamplifier requires an easy internal modification. To change, simply locate and remove the pair of 62,000 ohm (blue-red-orange) resistors on the PC-5 printed circuit board in the preamp. Earlier PAS-2 and PAS-3 preamplifiers cannot be modified for use with the Stereo 150. Some other tube type preamplifier brands may require modification for optimum performance into a 35 K ohms load.

It is desirable to keep the left and right input cables close together throughout their run to avoid extraneous hum.

### OUTPUT

Select speaker leads of sufficient size to preserve the high damping factor of your amplifier. Standard 18 gauge lamp cord ("zipcord") is suitable for distances up to 30 feet with an 8 ohm load. A larger wire size is advised for longer distances—#16 for 50 feet; #14 for 80 feet. #18 and #16 lamp cord is available from hardware and electrical supply stores, and is the easiest to use and conceal. For a 4 ohm load, these maximum distances should be cut in half, if you wish to maintain high speaker damping.

Connect the left speaker to Channel A output terminals. Be sure to maintain similar wiring "sense" for each speaker, so that they will be connected *in phase*. Normally the "—", common, or ground terminal of each speaker is connected to the black amplifier terminal. Proper phase sense is easily maintained with lamp cord because one conductor is coded with a molded ridge on the outer insulation.

Two speakers are connected in phase when maximum low frequency output is heard when they are driven from a monophonic source. Lowered output is observed when the connection to one of the speakers is reversed (out of phase, or reversed polarity). When using multiple speakers on each channel, or with 4-channel systems, it is important that all of the speakers in the same area be wired in phase.

The amplifier terminals are 3-way binding posts which will accept single or double "banana plugs," spade lugs, or simply stranded wire. If stranded lamp cord is used, the wire ends should be "tinned" with solder first to avoid fraying. To connect the wire, unscrew the terminal cap until the vertical hole through the metal shaft is uncovered from below, push the wire end through the hole, and tighten the cap.

Make certain that no wire strands can touch other than the intended terminal. Double banana plugs (from radio supply houses) are the most convenient connectors, and are simply inserted into the ends of the terminals. They are particularly useful if a second set of speakers is to be connected in parallel, as they plug into one another.

## OPERATION

Almost silent turn-on and turn-off transients are a result of nearly equal charge (or drain) of the plus and minus supply voltages. However, harmless low frequency movement of the speaker may be observed as the voltages stabilize at turn-on, and decay at turn-off.

The Stereo 150 includes circuits to protect against the hazards of short circuit outputs, and abnormal load demands. Good operating practice will avoid the need to test their effectiveness, however, for there is no such thing as absolute protection from abuse.

The combination of moderately high power potential and the relative fragility of most high quality speakers makes it imperative that you take care to avoid such common faults as dropping a stylus (tone arm) onto a record; allowing the arm to skid across the record; or flicking the stylus with your finger while the volume is up on the preamplifier. These are typical errors which generate heavy low frequency pulses capable of severely overdriving the amplifier and consequently the speaker at subsonic frequencies.

### LOUDSPEAKER RATINGS

Nominal speaker power ratings are a matter of concern. There is currently no U.S. standard. Manufacturers usually provide a "music power" rating, or indicate amplifier power limits. These should not be confused with continuous, or "rms" power acceptance for a sustained period which will be substantially lower. It is rare for a speaker to be able to handle as much power near the frequency extremes as in the midrange. Single woofer high fidelity speaker systems rarely have "music" ratings as high as 100 watts, or continuous duty wide band sine wave ratings as high as 40 watts.

In view of the power limitations of most high accuracy speaker systems, the connection of two or four similar speakers in the same location to a single channel is often advisable, if high signal levels are wanted. Lacking more definitive advice, a rough test is to place your hand in front of the woofer when playing a loud passage at your anticipated listening level. If you can feel *any* heat generated by the voice coil, you should consider the need for additional speakers to reproduce that level safely. When

The black "common" output terminals are electrically connected internally. They are also connected to the chassis, so the Stereo 150 may be used with special output connections which require common grounds. You must be *certain* that the polarity of such output connections is never reversed, however, so that the red "hot" terminals can never be connected together in other equipment.

### AC POWER

The power cord should be plugged into a switched outlet on a control preamplifier, such as a Dynaco PAT-5, PAT-4 or PAS-3X. Once connected, the POWER switch on the Stereo 150 may remain on, and thereafter the POWER switch on the preamplifier will turn the Stereo 150 on and off.

If a preamplifier is not employed, the amplifier's line cord may be plugged into a conventional wall outlet, and the POWER switch on the Stereo 150 used to turn it on and off.

The POWER switch is the only control function on the Stereo 150. The word POWER on the left front of the amplifier glows blue when the amplifier is on.

high output, high accuracy reproduction is desired, a series-parallel connection of four 8 ohm speakers (such as the Dynaco A-35) on each channel provides a resultant 8 ohm load with exceptional power handling capacity.

Speaker impedance varies with frequency—often by a factor of 4 or 5 to 1. Even the least variable speakers, like Dynaco's, have a 2:1 change. While most nominal ratings are close to the actual minimum impedance, when combinations approach the 4 ohm minimum recommended amplifier load, the safest procedure is to measure the resistance across the terminals with an ohmmeter. Speaker impedance usually varies upwards from this value. Use this figure to determine whether multiple speakers (on each channel) should be connected in parallel:

IN PARALLEL:	IN SERIES:	IN SERIES-PARALLEL:
$2 \times 8 \text{ ohms} = 4 \text{ ohms}$	$2 \times 4 \text{ ohms} = 8 \text{ ohms}$	$4 \times 16 \text{ ohms} = 16 \text{ ohms}$
$2 \times 16 \text{ ohms} = 8 \text{ ohms}$	$2 \times 8 \text{ ohms} = 16 \text{ ohms}$	$4 \times 8 \text{ ohms} = 8 \text{ ohms}$
$4 \times 16 \text{ ohms} = 4 \text{ ohms}$	$4 \times 4 \text{ ohms} = 16 \text{ ohms}$	$4 \times 4 \text{ ohms} = 4 \text{ ohms}$

These simple examples assume identical models. It is not wise to connect dissimilar speakers in series or in series-parallel because of adverse audio effects.

### LOUDSPEAKER FUSING

The outputs of the Stereo 150 are provided with speaker fuses. The 3 ampere, 3AG fuses supplied will not fail when the amplifier is operated at full power (75 watts into 8 ohms), and therefore they provide NO PROTECTION for your speakers. Please understand that a fuse in series with the output of an amplifier is supplied primarily as protection for the speaker, although it does provide a measure of protection for the amplifier circuits. Nevertheless, the size of the fuse should be determined by the type of speaker you are using.

Since the power passed by a fuse varies with load impedance, and test signals have little correlation to music signals, and fuses vary in their tolerance of music overloads, the protective rating determination for a speaker is largely empirical. Logic would suggest the smallest value fuse which does not blow frequently at what are high, but

nonetheless safe levels for your speaker. There are few speakers capable of safely handling more power than will blow a 2 ampere fuse.

The speaker manufacturer who specifies a fuse rating solves your problem. Lacking this, remember that a fuse will not blow until a *sustained* signal *well above* its rating is imposed for a time. A slo-blo fuse will allow appreciably more overdrive than the same value standard fast-blow type, and is thus not generally recommended for speaker protection.

The chart below shows the highest *sustained* power level which will *not* blow the fuses shown. Remember that speaker impedance typically rises well above its nominal value. Experience suggests that on this basis power levels of 10 watts are safe starting points for most high fidelity speakers using a single woofer.

3AG FUSE TYPE	4 OHMS	8 OHMS	16 OHMS
1/2 ampere	1 watt	2 watts	4 watts
3/4 ampere	2.2 watts	4.5 watts	9 watts
1 ampere*	4 watts	8 watts	16 watts
1 1/2 ampere**	9 watts	18 watts	36 watts

\* Dynaco A-10, A-25 and A-35 speakers

\*\* Dynaco A-25XL, A-40XL, and A-50 speakers

## MONOPHONIC OPERATION

A single channel of the Stereo 150 may be operated at any time, provided there is no input signal to the unused channel. There is no need for any load resistor on the unused channel, for the design is completely stable.

By simple internal strapping, it is practical to combine the two channels for monophonic 150 watts operation (@ 8 ohms). This connects the outputs in *parallel*. Once

strapped, the *output* connections for *Channel B* are used (Channel A output is disconnected). Either (but not both) of the *inputs* may be used, as they are also connected together.

To combine the channels for mono usage, two internal changes are required. We suggest tilting the back panel outward to make the first change easier. Refer to the Pictorial Diagram supplied with this manual:

1. Install the strapping jumper assembly (a 2" length of wire with a connector on each end—see page 19, step 30) onto the pair of 5/8" long pins on the PC-36 audio circuit board (the large board). The pins are located on the components side of the board, near the bottom center. Support the board from the back (foil side) as you push a connector onto each pin—it is a tight fit.
2. Remove the female Molex connector from its mating plug on the top right of the PC-37 power supply board (as viewed from the back of the amplifier). Install the connector on the corresponding plug on the top *left* of PC-37, adjacent to the connection of the red power transformer leads.

With the outputs thus connected in parallel, a conventional speaker connection is made to the B Channel outputs. The black connection is ground; red is "+". However, it is important to understand that the speaker fuses for the A Channel and B Channel are now connected in parallel. Therefore, their rating should be cut in half to maintain the same speaker protection. For example, if the manufacturer of your speaker recommends a 1 1/2 ampere fuse to protect it, a 3/4 ampere fuse should be installed in each of the speaker fuse holders, when the Stereo 150 is operated in the mono mode.

## ASSEMBLY INSTRUCTIONS

### GENERAL ASSEMBLY INFORMATION

Construction of the Stereo 150 is very simple when compared to other kits. The printed circuit board for audio has been preassembled and tested to save you much of the work, and the assembly that remains is in an open, uncluttered layout to make wiring quick and easy. The construction time will be several hours. It is better to work slowly and carefully rather than concern yourself about the time.

When you unpack the kit, check off the components against the parts list on page 24. Separate the hardware items in an egg carton or similar container. You can identify unfamiliar parts by checking them against the Pictorial Diagram, bearing in mind that the drawing is necessarily somewhat distorted for visual separation.

Have the proper tools at hand before starting construction. The tools necessary are:

1. A pencil-type soldering iron with a 3/16" tip or smaller of 40 to 60 watts rating, with a tip temperature of 700 to 800° F.
2. A damp sponge or cloth to wipe the tip of the iron.
3. 60/40 *rosin core* solder not larger than 1/16" diameter.
4. A medium sized screwdriver (1/4" blade).
5. A #2 Phillips screwdriver (medium sized, cross-pointed tip).
6. Long nosed and diagonal cutting pliers.

7. Heavy "slip joint" pliers.
8. A single edged razor blade or inexpensive wire stripping tool for removing insulation.
9. Wood toothpicks.
10. Transparent or masking tape.

We do *not* recommend using a soldering gun. Not only can a gun provide more heat than is necessary—an unskilled user might damage printed circuit boards—but also many users tend to make poor solder connections, simply because they do not wait long enough for the gun to reach its operating temperature each time. Use a conventional pencil type iron.

A good solder connection does not require a large amount of solder around the joint. A well-made connection looks smooth and shiny because the solder *flows into the joint* when both parts are hot enough.

There are four steps to making a good solder connection:

1. Make a good mechanical connection.
2. Heat *both* parts with the tip of the iron *at the junction*.
3. Apply solder to the *junction* until it melts and flows.
4. Allow the connection to cool undisturbed.

## ALL SOLDERING MUST BE DONE WITH A GOOD GRADE OF ROSIN CORE SOLDER.

Under no circumstances should acid core solder be used. Unmarked solder, cheap solder or any of doubtful origin should be discarded, and *separate solder fluxes should never be used*. The warranty is voided on any equipment in which acid core solder or acid type fluxes have been used. Silver solder is not suitable. The recommended solder is 60/40 (60% tin, 40% lead) **ROSIN CORE**. Do not confuse this with 40/60, which is harder to use.

You should realize that many of the more delicate components are less likely to be damaged in the soldering process if you use a hot iron for a short time, rather than a cooler iron for a longer period. You will also make a better connection with the hot iron. If you keep the iron clean by wiping the tip frequently, and occasionally add a small amount of solder to the tip, it will aid the transfer of heat to the connection. Do not allow too much solder to build up on the tip though, or it may fall onto adjacent circuitry.

One of the best ways to make a good mechanical connection is to bend a small hook in the end of the wire, and then to crimp the hook onto the terminal lug. The amount of bare wire exposed need not be exactly  $\frac{1}{4}$ -inch, but if it is too long, the excess might touch another terminal lug or the chassis. Do not wrap the wire around the lug more than one time, as this makes the connection difficult to remove if an error is made.

Many of the wiring steps will call for "preparing" a wire of a certain length and color. This involves cutting the necessary length of wire and stripping  $\frac{1}{4}$  inch of insulation from each end. This is most easily done with wirestrippers, but diagonal cutters can be used if you are careful not to nick the wire and weaken it.

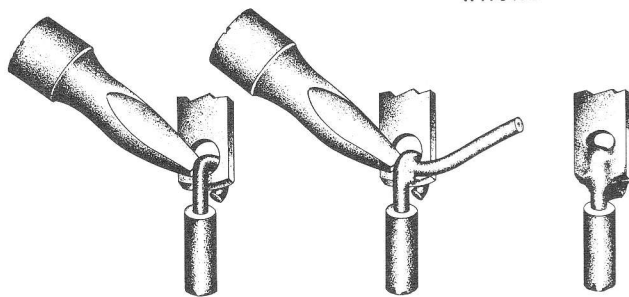
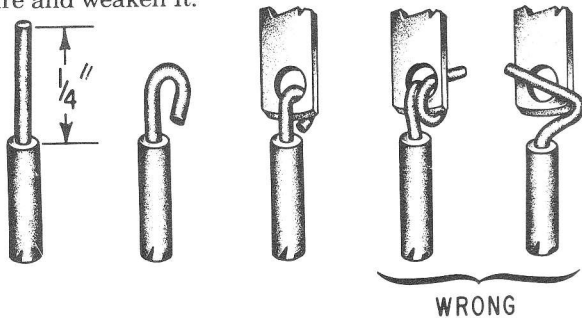

When soldering a lead to a numbered, plated-through hole on a circuit board, push the lead through the hole first. *Do not push the wire all the way into the hole up to the insulation*. Apply the solder and the hot iron at the same time to the junction of the hole and lead. The solder should melt very quickly; it should flow easily and fully into the hole and completely around the lead. Remove the iron and allow the connection to cool. If in doubt of your connection, you may also wish to apply solder and iron to the hole and lead from

the other side of the board. It is *essential* to have a smooth, shiny flow of solder from the lead to the plated circuitry on the board.

## WIRING THE KIT

The position of all wire leads should follow the diagram closely, bearing in mind that the pictorial diagram has necessarily been distorted somewhat to show all connections clearly. See that uninsulated wires do not touch each other unless, of course, they are connected to the same point. It is especially important that uninsulated wires or component leads or terminals do not touch the chassis accidentally.

Whenever one wire is to be soldered to a connection such as a lug terminal or hole, the instructions will indicate this by the symbol (S). If more than one wire is to be soldered to the same point, the instructions will cite the number of wires that should be connected to that point when it is to be soldered. If no soldering instruction is specifically given, do not solder; other connections will be made to that point before soldering is called for.

Check your work after each step, and make sure the entire step has been completed. When you are satisfied that it has been correctly done, check the space provided and go on to the next step. Be sure you read carefully the explanatory paragraphs in the assembly instructions.

The PC-36 printed circuit board, which includes most of the electronic components for the Stereo 150, has been in-circuit tested before being packed into the kit. These tests include every significant performance criterion—gain, power, distortion, frequency response, functioning of protective circuitry—as well as provide precise adjustment of necessary circuit parameters to assure that your amplifier will meet or exceed the specifications when these instructions are adhered to, and all connections have been properly completed.

Where stranded wire is used, as on the transformer leads, be very careful not to cut through the strands when stripping the end. Where stranded wire is supplied for hookup wire in the kit, the strands will be bonded together to minimize this likelihood and make handling easier.

All mounting screws are installed from the *outside* of the chassis, and a nut with lockwasher attached, called a **KEP nut**, is used except when otherwise specified.

This kit uses a variety of hardware. Before starting assembly, separate all the hardware by using an egg carton, muffin pan, or small cups. #4, #6, #8 and #10 machine screws with oval (binder) heads are used in various lengths, but much of the hardware used is #6 binder head in a  $\frac{1}{2}$ " length. There are also #6 *flat head* screws, which are used only when called for on the front panel. To simplify construction, nuts with lockwashers attached, called **KEP nuts**, are supplied. Two types of sheet metal screws are used—one kind in black with a cross-slotted (Phillips) head, and the second kind in bright metal with a coarse thread and a slightly tapered, blunt end.

The center "C" (collector) lugs of the sockets for the output transistors have a notch rather than a hole for mechanical connection. Crimp the wire in a tight "U" in the notch to hold it securely for soldering. In such cases, it may be helpful to strip *slightly* more than the standard  $\frac{1}{4}$ " of insulation from the wire. Note that the mechanical crimping of the wire serves *only* to hold the wire stationary while the solder is applied. The integrity of every solder connection is essential.

Transistor equipment will not tolerate wiring errors, sloppy or incomplete soldering. **TAKE THE TIME TO BE NEAT AND ACCURATE**, and your amplifier will operate properly at first, and for many years.

## MECHANICAL ASSEMBLY

Much of the hardware used to mount the parts in this kit is #6-32 x 1/2". If no mention is made of the type of hardware, use this size. A set is one screw and one KEF nut.

Select the painted back panel. Note that the outside surface is printed with white lettering. Some of the parts will be mounted from the outside, and others from the inside.

- 1( ) Select the dual input socket strip, the matching insulator strip, and two #4 (smallest) screws and KEF nuts. This input strip mounts *inside* the center bottom of the back panel. Insert the screws from the outside, install the insulator first on the inside, followed by the input strip, and fasten with the KEF nuts. The input strip mounts in either direction. Make sure that the metal of the socket strip does not touch any surface of the back panel, and firmly tighten the hardware.
- 2( ) Select the two round speaker fuse holders, and install them from the outside. Their hardware is attached. The rubber washer stays outside the panel, and the flat side of the mounting hole engages a similar flat on the holder for proper positioning. Secure each holder with its lockwasher and nut.
- 3( ) Install the two *red* binding posts in the holes just above each fuse holder. Their hardware is attached. See the sketch below. The shoulder piece goes on the outside of the back panel with the smaller diameter portion protruding through the hole. The insulating plastic ring fits over it inside the back panel, followed by the washer. Before tightening the first nut, unscrew the outside knurled end and observe the hole in the metal shaft. For greater convenience in connecting leads to these posts later, rotate the assembly so that this hole is in a vertical position. Slip a short piece of wire through the hole for easy observation as you firmly tighten the first nut. Slide on the connecting lug, and fasten with the second nut. Position each connecting lug as shown in the Pictorial Diagram, and keep the hole vertical as you firmly tighten the second nut.

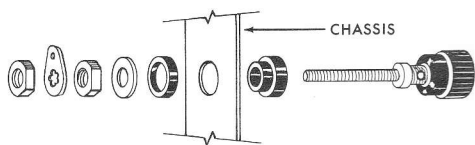

- 4( ) In a similar manner, install the two *black* binding posts in the holes adjacent to the red posts. Keep the hole in the metal shaft vertical, and note the correct lug placement in the Pictorial Diagram.
- 5( ) Select one of the black heat fins, a 6-lug terminal strip, a small thermal sensor (mounting lug attached), and six sets of #6 hardware. We recommend that you now install masking or transparent tape around the outer edges of the black heat fins

to protect their finish and your work surface. The back panel has two groupings of holes, and the central portion of the heat fin has matching holes. Place the flat of the heat fin against the *outside* of the back panel so that all the holes match. If a "T" is stamped in the heat fin, this indicates the top. Insert the screws from the *outside* in the six *smaller* holes. Mount the thermal sensor on the *inside* over the screw on the right center. Then mount the terminal strip on the inside over two screws on the right, as shown in the Pictorial Diagram. Fasten with a KEF nut on all six screws. Position the thermal sensor as shown in the Pictorial Diagram, and tighten the two center screws very firmly. The other four screws should remain finger tight until later.

- 6( ) Select the remaining black heat fin, the other 6-lug terminal strip, the last thermal sensor, and six sets of #6 hardware. In a similar manner tape the outer edges of the heat fin, and mount it to the back panel. Match the remaining group of holes in the back panel with those of the heat fin, mount the thermal sensor first, and then the 6-lug terminal strip on the inside, and firmly tighten only the two center screws.

Set this assembly aside, and place the front panel in front of you. Note that the edges of the inside surface are turned up. The few parts mounted on this panel will be mounted on the inside.

- 7( ) Select the power switch, two #6 screws with *flat heads*, and two lockwashers. Note that each lockwasher is deliberately supplied one size larger than the screw, to provide greater thickness. Insert the screws from the outside in the countersunk holes provided, place the lockwashers over the screws on the inside, and install the power switch so that its solder lugs are nearest the *center* of the panel. Nuts are not required, for the switch has tapped, extruded mountings.
- 8( ) Select the two lamp brackets, two #6 screws with *flat heads*, two lockwashers, and two #6 KEF nuts. Insert the screws from the outside in the two countersunk holes *above* the small cutout on the other end of the panel, place the lockwashers over the screws on the inside, install each bracket, and fasten with a nut on each screw. Position the brackets at an angle, as shown in the Pictorial Diagram (so that the lamps, when installed, will appear in the center of the rectangular opening), and tighten the screws firmly. [If the MC-2 meter kit has been obtained, skip this step. The lamp brackets are not used.]

This completes the mechanical assembly of the front panel. Set this assembly aside, and place the main chassis bottom plate in front of you, flanges down.

- 9( ) Select the four rubber feet, and the four 3/8" #8 screws. Insert a screw through each foot, and then mount a foot at each corner of the chassis on the *outside* (flanges down). No other hardware is required, for the chassis is supplied with threaded nuts for these screws.

Turn the chassis over, flanges up, with the two pairs of adjacent parallel slots at the back toward you.

- 10( ) Select the power fuse block, and the remaining #4 screw and nut (the smallest hardware). Insert the screw from the outside, and install the fuse block in the smallest hole at the left front of the chassis. See that the block is parallel to the adjacent flange and to the left of the two nearby chassis "dimples". Tighten the hardware.
- 11( ) Select the 2-lug terminal strip, and one set of #6 hardware. Install the strip in the hole adjacent to the fuse block. Position the strip parallel to the fuse block, as shown, and tighten the hardware.
- 12( ) Select one of the large 10,000  $\mu\text{f}$  capacitors, one of the large circular capacitor mounting brackets, and four sets of #6 hardware. *Do not remove the clear plastic outer insulation from either of these capacitors.* This bracket will be installed to the left of the single horizontal slot in the chassis. Note in the Pictorial Diagram the correct position of the clamp, and also the direction of the clamping screw. One set of #6 hardware is first installed in the clamp before mounting. Insert the capacitor in the bracket, position the "+" on top of the capacitor on the left as shown, and temporarily tighten the clamp. Now mount the bracketed capacitor with the remaining hardware. Fasten with the hardware only finger tight at present.
- 13( ) Select the remaining large capacitor, the remaining bracket, and four more sets of #6 hardware. Slide the capacitor into the bracket as before with the clamping screw and mount the bracketed capacitor to the right of the single slot. Position the "+" as shown, tighten the clamp temporarily, and fasten with the outer hardware only finger tight.
- 14( ) Select the power transformer, the four  $\frac{1}{2}$ " #10 (largest hardware) screws, the four large flat washers, and the four #10 KEP nuts. (Do not confuse these with the  $\frac{3}{8}$ " #10 screws, which have lock-washers attached). Mount the transformer on the center front of the chassis with the black, black-white, violet and violet-yellow leads toward the left front, and the orange, red, and red-yellow leads toward the right back. Place a large washer on top of each transformer foot before the nut is installed, and firmly tighten the hardware.
- 15( ) Select the front panel assembly, and four  $\frac{3}{8}$ " #6 black Phillips head *sheet metal* screws. Place the front panel in position inside the flanges of the chassis, after seeing that the transformer leads are clear of the panel at the bottom. Insert a screw in the corner hole of the flange at each end, and the remaining two in the chassis at the bottom. The screws cut their own threads and therefore some force is required. Use a #2 Phillips screwdriver to tighten the hardware.

The next two steps describe the mounting of the output transistors on the back panel heat fins. A thin uniform film of silicon thermal compound is needed on the mating surfaces to provide maximum heat transfer from a transistor to the heat sink. Excess compound will be messy, and is a disadvantage, since the compound is intended only to fill in minute voids between flat surfaces.

This thermal compound can be most annoying if carelessly handled. Clean up any excess with paper tissues as you go along. It is difficult to remove from clothing, and the best removal agent, if needed, is Freon—a degreasing agent available in a pressure spray can at electronic supply houses.

One of the easiest ways to handle this compound is to apply it with the blade of a screwdriver or a toothpick. However, the screwdriver used should be other than the one employed to install the hardware.

Set the chassis aside and return now to the back panel. The four output transistors plug into sockets on the heat fins. Note that the holes for the transistor pins in the sockets are off-center. The longer end is identified with an "E" stamped in the fiber adjacent to a lug, and the shorter end is stamped with a "B" also adjacent to a lug. The center "C" lug is unmarked.

The metal insulators (shaped like the transistors) are hard-anodized for excellent thermal conductivity with electrical isolation. Do not scratch them. Apply the thermal compound in a *very thin film* to both surfaces while holding it by the tab at the "B" end. Position the insulator correctly, and install it on the transistor. Then the combination is installed on the outside of the heat fin and plugged into a socket on the inside. The longer "E" end of each socket is positioned to the right, as viewed in the Pictorial Diagram.

The simplest procedure seems to be the following: after placing the compound coated insulator on the transistor, wipe each transistor pin clean of all compound. Then position the combination to properly match the mounting holes, and press it against the heat fin on the outside with a *slight* twisting motion to assure uniform contact. While holding it in place, snap the socket over the pins from the inside. When firmly engaged, this will hold each assembly temporarily so that the screws can be installed from the outside in one final operation to minimize smearing.

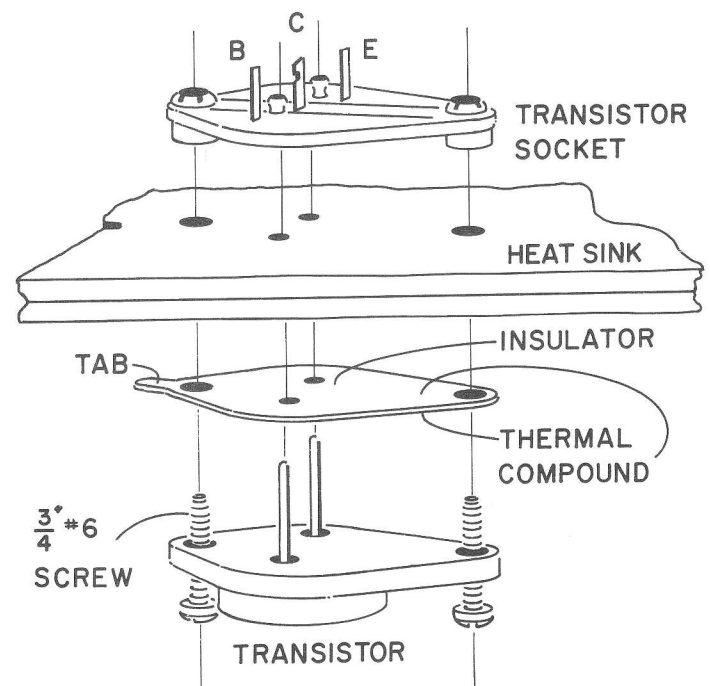



- 16( ) Select the two transistors, Part #561356 (2N6029 or 2N6030), two metal insulating wafers, two transistor sockets, the thermal compound, and four of the  $\frac{3}{4}$ " #6 sheet metal screws (coarse threads with slightly tapered ends). Do *not* confuse these transistors with the two #571104 transistors, which look the same, but will be mounted in the next step. First check to see that the transistor pins are straight. These two transistors will be mounted from the *outside* at the *bottom* of the two heat fins in positions Q12A and Q12B. Apply a *thin* film of compound to both sides of the insulator, position it correctly, and install it over the transistor pins. *Wipe the pins clean*, and plug each assembly through the heat fin into the transistor socket. Secure each with two sheet metal screws.
- 17( ) Select the two transistors, Part #571104 (2N5629 or 2N5630), the other two insulating wafers, the two remaining sockets, and the last four  $\frac{3}{4}$ " sheet metal screws. Check for straight transistor pins. Apply a thin film of compound to the insulating wafers as before, wipe the pins clean, install these from the *outside* at the *top* of the heat fins in positions Q11A and Q11B, and snap them into the sockets. Secure with the sheet metal screws.

This completes the need for the compound. Wipe off all the excess, including the threads of the transistor mounting screws, to avoid smears as you complete construction.

- 18( ) Select the two perforated black transistor covers. Their installation requires *removal* of the two sets of #6 hardware used to attach the tops of the heat fins to the back panel, and loosening the two sets of hardware used to attach the bottoms of the heat fins. Slip one end of a cover—they are made symmetrically—under the hardware at the bottom, and reinstall the hardware at the top. Tighten all eight screws *very* firmly.

## WIRING THE HEAT SINK AND PC-36

Be particularly careful handling the preassembled audio circuit board, for it represents a substantial portion of the cost of the Stereo 150. Many of the components stand upright on the board, and careless handling can unduly flex and possibly break their leads. There are also four adjustable potentiometers on the circuit board whose values (positions) have been precisely set under operational test conditions for optimum performance. *Be very careful* that none of these is disturbed when handling the board.

- 1( ) Select the PC-36 audio circuit board, the two Z-shaped metal mounting brackets, and four sets of #6 hardware. Install the brackets on the *foil side* (not the components side) of the board, with the long side against the board, and the first bend at the row of holes at the bottom. Insert the screws first through the board from the components side, then through the bracket, with each nut against the bracket. Firmly tighten the hardware.

On the Pictorial Diagram you will find a template of the numbers for the plated through holes on PC-36. If the numbers for the holes are not already etched on the *foil side*, cut out the template and affix it to the *foil side* of PC-36 so that it lies between the row of holes at the bottom and the four holes #27, #28, #29 and #30 near the center.

You may use transparent tape, or you may push the template onto the screws at the bottom to hold it in place as you solder to the holes.

- 2( ) Place the back panel assembly in front of you, so that it lies on its heat fins, and positioned so that the top is toward you. Place PC-36, *foil side* up, against the bottom of the back panel, so that holes #12 and #15 on the board are adjacent to input socket lugs #4 and #1, respectively. Support the board about  $2\frac{1}{2}$ " off the work surface on a box, such as a tissue box, so that the row of holes on PC-36 is adjacent to the bottom flange of the back panel.

In succeeding steps connections will be made to plated through holes on PC-36. A good connection is more certain if the tip of the wire is first "tinned" by heating it and applying a *very small amount* of solder before it is connected to the hole. Insert the wire in the hole so that bare wire is visible on *both* sides of the board. Let the soldering iron contact the junction of wire and board circuitry as you feed solder to the junction. Solder should flow smoothly from the circuitry, *around the hole* to completely surround the wire. Keep the wire steady while the connection cools, and then wiggle it to make sure the connection is secure. If in doubt, reheat the connection and add more solder.

Do *not* add solder to the holes before a wire is inserted. If you do, it will be difficult to find the hole to clear it. However, should you solder a wire in error to a wrong hole, first remove the wire by using the iron, and while the solder is still hot, push a toothpick through the hole to clear it.

The following connections will be made to the foil side of the board.

- 3( ) Prepare a  $1\frac{3}{4}$ " (4.5 cm) black wire. Connect one end to hole #14 on the board (S). Connect the other end to input socket lug #2 (S).
- 4( ) Prepare another  $1\frac{3}{4}$ " (4.5 cm) black wire. Connect one end to hole #13 (S). Connect the other end to input socket lug #3 (S).
- 5( ) Prepare a  $4\frac{1}{4}$ " (11 cm) blue wire. Connect one end to hole #23 (S). Connect the other end to *left* speaker fuse holder lug #2 (S).
- 6( ) Prepare a  $4\frac{1}{4}$ " (11 cm) yellow wire. Connect one end to hole #4 (S). Connect the other end to *right* speaker fuse holder lug #3 (S).

These wires will have stabilized the position of PC-36 relative to the back panel assembly.

- 7( ) Strip a  $1\frac{1}{2}$ " (4 cm) piece of insulation from the roll of black wire, and cut it into four equal lengths.
- 8( ) Select a 1,000 ohm,  $\frac{1}{2}$  watt resistor (brown-black-red), and cut its leads to  $\frac{5}{8}$ " (1.6 cm) each. Do not confuse it with the larger 10,000 ohm resistors (brown-black-orange). Slip a length of insulation onto each lead. Connect one lead to hole #15 (S). Connect the other lead to input socket lug #1 (S).
- 9( ) Select the remaining 1,000 ohm resistor (brown-black-red), and cut its leads to  $\frac{5}{8}$ " (1.6 cm) each. Slip the remaining lengths of insulation onto each lead. Connect one lead to hole #12 (S). Connect the other lead to input socket lug #4 (S).

Each lug of the 6-lug terminal strips T-1 and T-2 has two holes, the conventional one at the tip, and the other at the base through the insulating material. For ease of connection, several of the steps following will indicate soldering to the *tip* or to the *base* of a lug on these terminal strips. The two holes will be soldered independently.

- 10( ) Select one (either) lead of the thermal sensor S-1, and connect it to T-1 lug #1 at the *base*. Shorten the lead appropriately, and then solder. Similarly connect the remaining lead of S-1 to T-1 lug #2 at the *base* (S). Avoid shorting together these two bare wires.
- 11( ) Prepare a 2 $\frac{3}{4}$ " (6.5 cm) blue wire. Connect one end to hole #22 (S). Connect other end to T-1 lug #6 at the base.
- 12( ) Select a .33 ohm, 5 watt resistor, cut its leads to  $\frac{5}{8}$ " (1.6 cm) each, and bend the leads 90° to its body. Do not confuse it with the .27 ohm or 220 ohm resistors. Connect one lead from the right to T-1 lug #6 at the base (S-2). *Do not place the resistor against T-1, but mount it about  $\frac{1}{8}$ " (.3 cm) to the right of the terminal strip.* Connect the other lead to T-1 lug #4 at the base (S).
- 13( ) Select another .33 ohm, 5 watt resistor, cut its leads to 1 $\frac{1}{4}$ " (3.2 cm) each, and bend the leads almost 90° to its body. Connect one lead from the right to T-1 lug #6 at the *tip* (S). Place the resistor body to the right of the other .33 ohm resistor, leaving about  $\frac{1}{8}$ " (.3 cm) space between them. Connect the other lead to T-1 lug #3 at the base (S).
- 14( ) Prepare a 3 $\frac{1}{4}$ " (8.3 cm) yellow wire. Connect one end to hole #19 (S). Connect the other end to T-1 lug #4 at the tip.
- 15( ) Prepare a 1" (2.5 cm) yellow wire. Connect one end to T-1 lug #4 at the tip (S-2). Connect the other end to transistor socket Q12B lug E.

All diodes supplied have their cathode end marked with a stripe, an arrow head, or a colored tip. It is this *marked* cathode end that will be referred to in several subsequent steps. The sketch below shows the diodes more than double size.

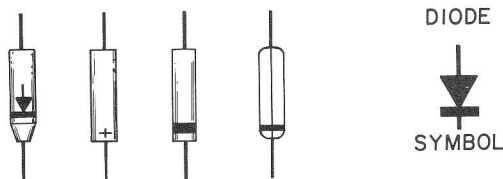

- 18( ) Prepare a 3 $\frac{1}{2}$ " (9 cm) black wire. Connect one end to hole #20 (S). Connect the other end to Q12B lug B (S).
- 19( ) Prepare a 3 $\frac{3}{4}$ " (9.5 cm) yellow wire. Connect one end to hole #21 (S). Connect the other end to T-1 lug #3 at the tip.
- 20( ) Prepare a 2 $\frac{1}{4}$ " (6 cm) yellow wire. Connect one end to T-1 lug #3 at the tip (S-2). Connect the other end to Q11B lug E.
- 21( ) Select another diode, part #544012. Cut the lead on the *marked* end to  $\frac{3}{4}$ " (2 cm), cut the other lead to  $\frac{1}{2}$ " (1.3 cm), and bend the leads 90° to its body. Connect the *lead without marking* to Q11B lug E (S-2). Connect the marked lead to the notch in Q11B lug C. Note that the marked end of this diode and the one connected to Q12B point in opposite directions.
- 22( ) Prepare a 5 $\frac{1}{4}$ " (13.5 cm) blue wire. Connect one end to hole #25 (S). Temporarily insert a toothpick into hole #24, if desired. Bend a small hook around the other end, and connect it to Q11B lug C (S-2).
- 23( ) Prepare a 5 $\frac{1}{4}$ " (13.5 cm) black wire. Connect one end to hole #18 (S). Connect the other end to Q11B lug B (S).
- 24( ) Select one (either) lead of the thermal sensor S-2, and connect it to T-2 lug #7 at the base. Shorten the lead appropriately, and then solder. Similarly connect the remaining lead of S-2 to T-2 lug #8 at the base (S). Avoid shorting together these two bare wires.
- 25( ) Prepare a 2 $\frac{3}{4}$ " (7 cm) blue wire. Connect one end to hole #5 (S). Connect the other end to T-2 lug #12 at the base.
- 26( ) Select a .33 ohm, 5 watt resistor, cut its leads to  $\frac{5}{8}$ " (1.6 cm) each, and bend the leads 90° to its body. Connect the lead from the right to T-2 lug #12 at the base (S-2). Mount the resistor about  $\frac{1}{8}$ " (.3 cm) to the right of the terminal strip. Connect the other lead to T-2 lug #10 at the base (S).
- 27( ) Select the remaining .33 ohm resistor, cut its leads to 1 $\frac{1}{4}$ " (3.2 cm) each, and bend the leads almost 90° to its body. Connect one lead from the right to T-2 lug #12 at the tip (S). Position the resistor body to the right of the other .33 ohm resistor, leaving about  $\frac{1}{8}$ " (.3 cm) space between them. Connect the other lead to T-2 lug #9 at the base (S).
- 28( ) Prepare a 3 $\frac{1}{2}$ " (9 cm) yellow wire. Connect one end to hole #8 (S). Connect the other end to T-2 lug #10 at the tip.
- 29( ) Prepare a 1" (2.5 cm) yellow wire. Connect one end to T-2 lug #10 at the tip (S-2). Connect the other end to Q12A lug E.
- 30( ) Select a diode, part #544012. Cut the lead on the *marked* end to  $\frac{1}{2}$ " (1.3 cm), cut the other lead to  $\frac{3}{4}$ " (2 cm), and bend the leads 90° to its body. Connect the *marked* end lead to Q12A lug E (S-2). Connect the other lead to the notch in Q12A lug C.

Now turn to page 14.

## CIRCUIT DESCRIPTION

The components in the Stereo 150 have been selected to protect against failure, and all parts are operated conservatively to assure unaltered performance and proper operation for many years. The semiconductors have been thoroughly researched and selected for minimum noise and distortion in sustained use, and the printed circuit board associated with audio signals has been pretested in the circuit to insure that this unit will meet or exceed all specifications.

The amplifier stages are fully DC coupled, with a differential pair for the input, and a fully complementary output stage. Its power supply is a full wave bridge with 10,000 mfd capacitors on both the plus "+" and minus "-" supplies to provide excellent filtering and dynamic load stability. Protection circuitry includes two separate power supply fuses for each channel, volt-amp limiting, individual thermal sensing devices for each channel to reduce drive in case of high temperature, output fuses to protect the amplifier and speakers, and an AC line fuse.

### DIFFERENTIAL AMPLIFIER

Transistors Q101 and Q102, the input differential pair, are driven from a constant current source, transistor Q103, to optimize parameters for the input pair. Potentiometer P101 adjusts the current from transistor Q103, which in turn balances transistors Q101 and Q102 to control the DC offset of the amplifier.

### BIAS ADJUSTMENT

An adjustable electronic equivalent of a zener diode with negligible dynamic resistance is formed by transistors Q105 and Q106, resistors R109, R110 and R111, and potentiometer P102.

Thus the signal sees the bases of transistors Q109 and Q110 tied together. Potentiometer P102 adjusts the zener voltage to bias the amplifier for Class AB operation, and therefore determines the quiescent (idle) current in the driver and output stages. Complete circuit stability is assured by mounting transistor Q105 to thermally track the driver transistors and to provide temperature compensation for the amplifier.

### DRIVER AND OUTPUT STAGES

The driver and output stages of the Stereo 150 are of the full complementary configuration. Transistors Q109 and Q301 form a Darlington pair for the positive half of the signal, and transistors Q110 and Q302 form another Darlington pair for the negative half of the signal.

### PROTECTION

A volt-amp limiter circuit protects both the positive and negative halves of the driver and output stages. When the current through resistor R302 exceeds a preset limit, its resulting voltage drop turns on transistor Q107, and limits the drive to transistor Q109 until the current is reduced for the positive half of the circuit. The same operation takes place to protect the negative amplifier circuit through resistor R303 and transistor Q108, and limits the drive to transistor Q110. Diodes D301 and D302 across the output devices limit possible reverse voltage from inductive loads to 700 millivolts maximum. The thermal protection, unlike most circuits, does not interrupt the output of the amplifier. If the heat sink temperature of a channel rises to 75° C, the input signal to that channel is reduced to a safe limit.

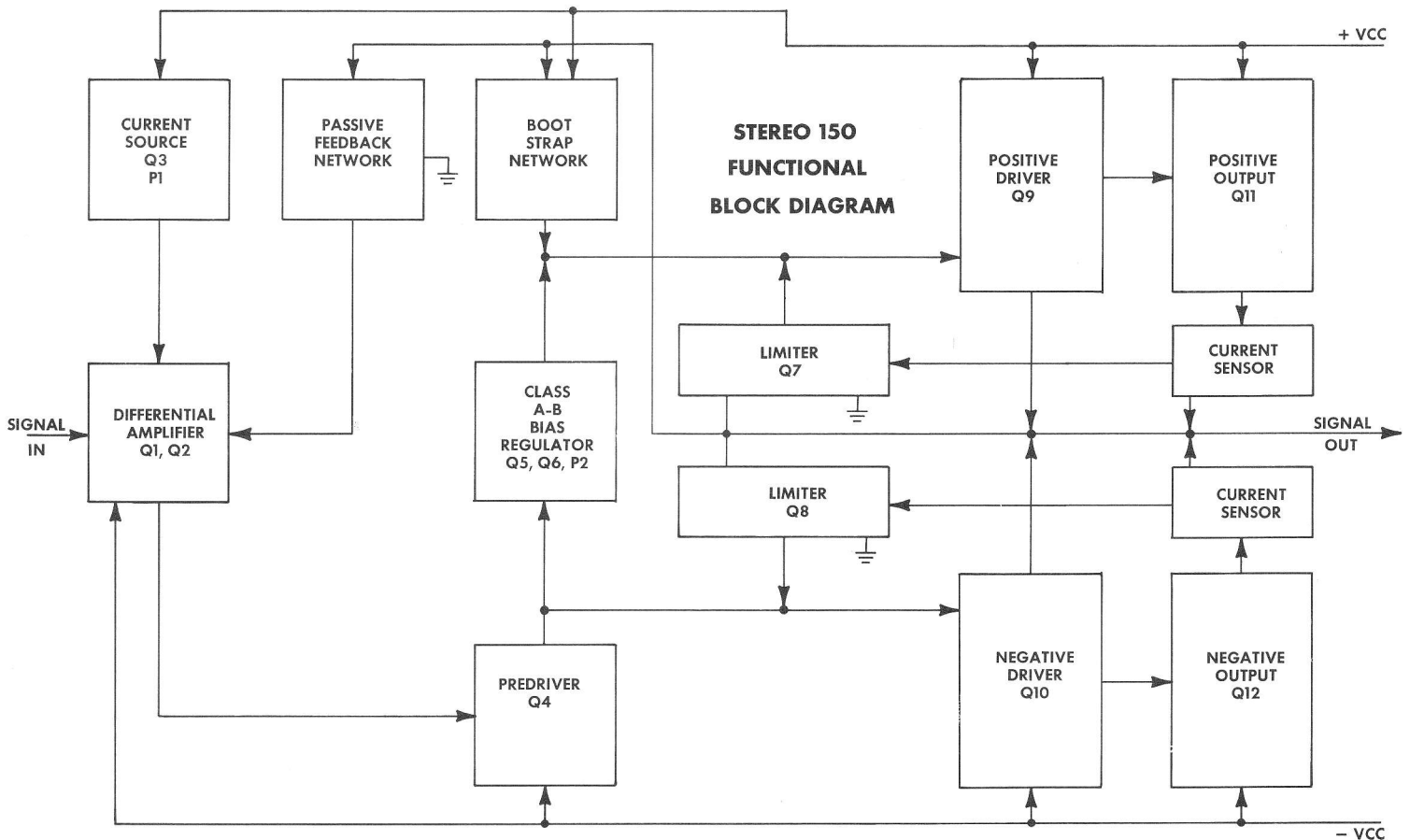

# SCHEMATIC DIAGRAM

## PC-36

ADD 100 TO ALL COMPONENT NUMBERS  
ONE CHANNEL SHOWN

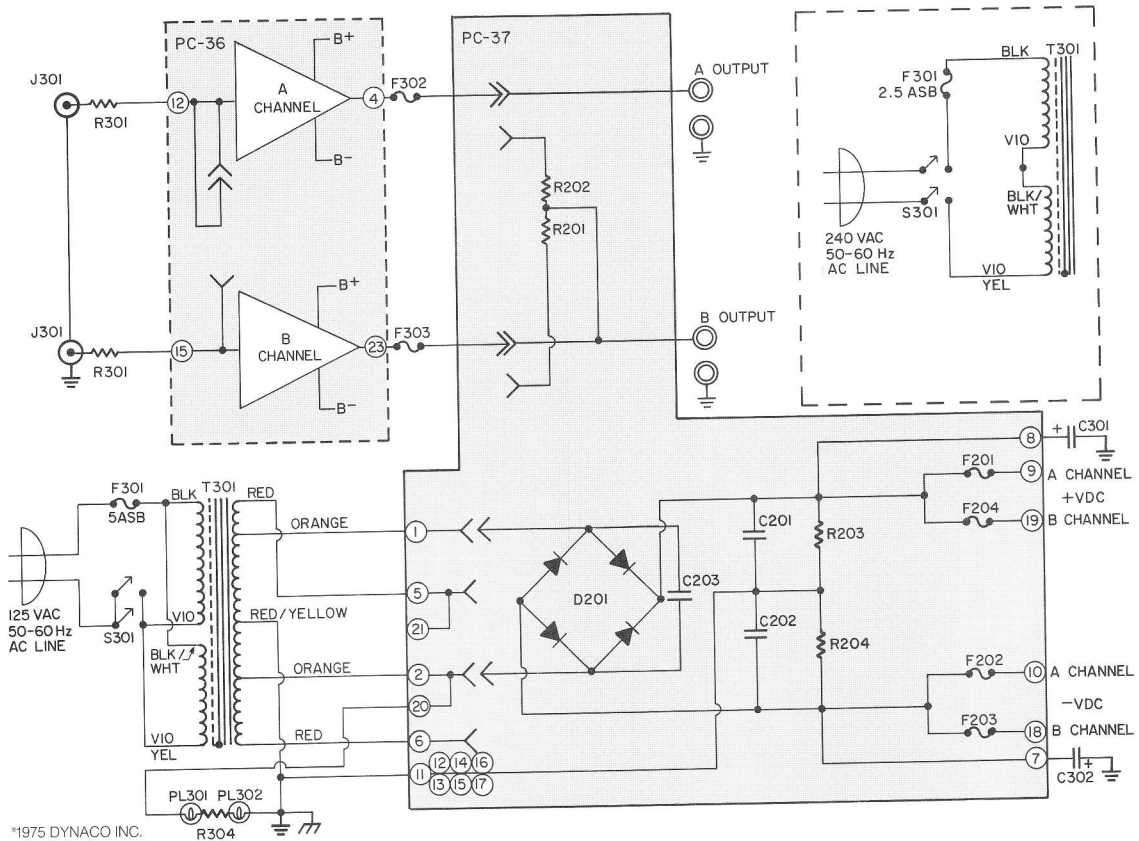
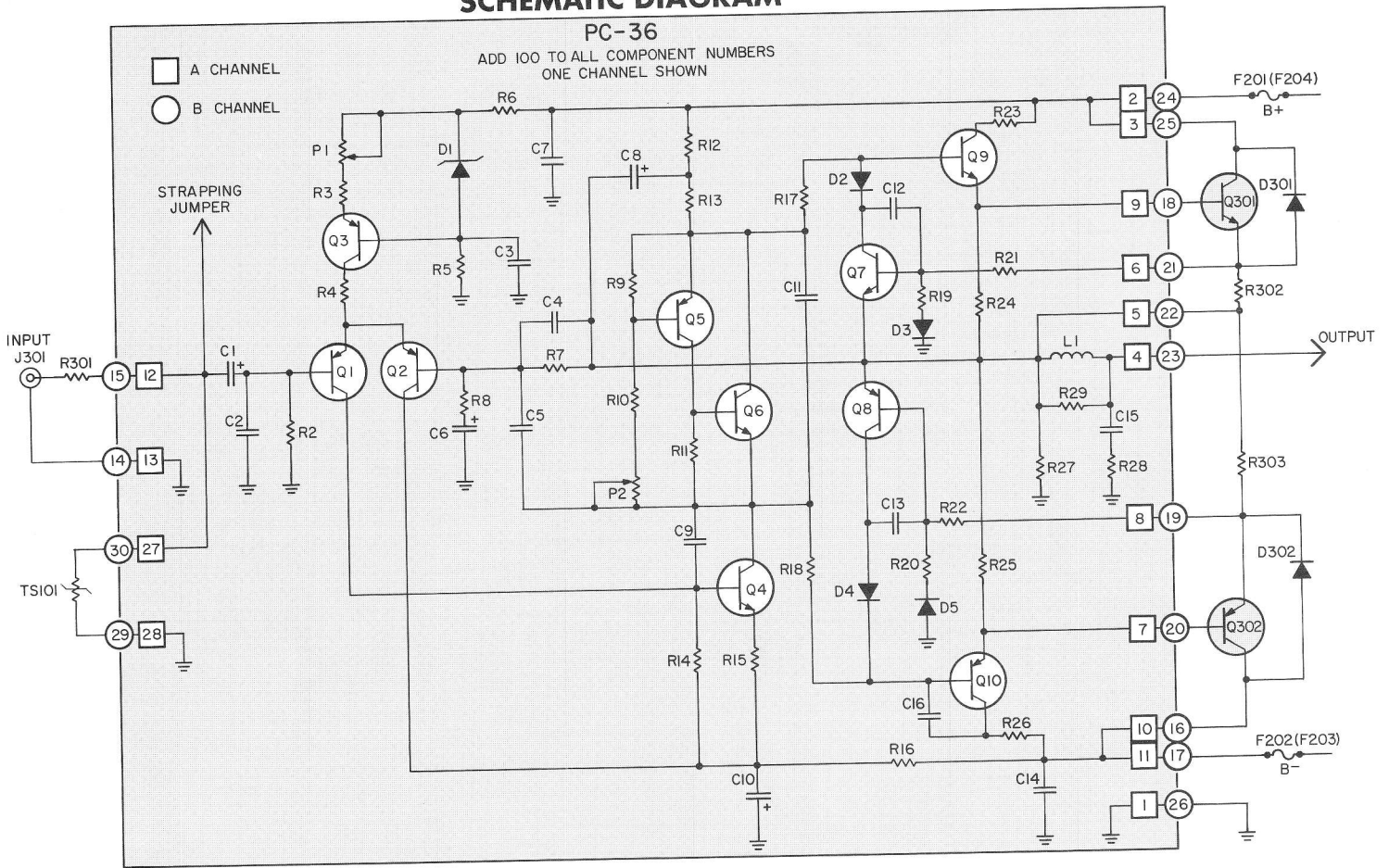

©1975 DYNACO INC.

## COMPONENT VALUES

All resistors are 1/4 w., 5% unless otherwise indicated

R102 47,000 ohms	119473		
R103 2,200 ohms	119222		
R104 1,000 ohms	119102		
R105 27,000 ohms	119273		
R106 270 ohms	119271		
R107 24,300 ohms, 1/8 w., 1% metal film	296-212432-330		
R108 1,000 ohms, 1/8 w., 1% metal film	296-211001-330		
R109 1,000 ohms	119102		
R110 2,700 ohms	119272		
R111 1,000 ohms	119102		
R112 3,300 ohms, 1/2 w., 5%	113332		
R113 5,600 ohms, 1/2 w., 5%	113562		
R114 560 ohms	119561		
R115 10 ohms	119100		
R116 270 ohms	119271		
R117 100 ohms	119101		
R118 100 ohms	119101		
R119 7,500 ohms	119752		
R120 7,500 ohms	119752		
R121 560 ohms	119561		
R122 560 ohms	119561		
R123 10 ohms	119100		
R124 39 ohms	119390		
R125 39 ohms	119390		
R126 10 ohms	119100		
R127 1,200 ohms, 2 w., 10%	118122		
R128 10 ohms, 2 w., 5%	110100		
R201 0.27 ohm, 5 w., 5%	306-120027-000		
R202 0.27 ohm, 5 w., 5%	306-120027-000		
R203 10,000 ohms, 1 w., 10%	115103		
R204 10,000 ohms, 1 w., 10%	115103		
R301 1,000 ohms, 1/2 w., 5%	113102		
R302 0.33 ohm, 5 w., 5%	306-120033-000		
R303 0.33 ohm, 5 w., 5%	306-120033-000		
R304 220 ohms, 3 w., 10%	120221		
L101 Audio choke wound on 1 ohm, 5 w., 5%	246-453002-000		
P101 5,000 ohms, trimpot	302-190502-000		
P102 1,000 ohms, trimpot	302-190103-000		
Q101 PNP transistor, 2N4889	340-562889-000		
Q102 PNP transistor, 2N4889	340-562889-000		
Q103 PNP transistor, 2N4889	340-562889-000		
Q104 NPN transistor, MPS L01	338-572101-000		
Q105 PNP transistor, BC 308B	340-567070-000		
Q106 NPN transistor, SE6020	338-577021-000		
Q107 NPN transistor, MPS A20, BC 237A	338-577020-000		
Q108 PNP transistor, BC 308B	340-567070-000		
Q109 NPN transistor, TIP 31C	338-577031-000		
Q110 PNP transistor, TIP 32C	340-567032-000		
Q301 NPN transistor, 2N5630	571104		
Q302 PNP transistor, 2N6030	561356		
D101 Zener diode, 14 v., 5%, 1N5244	264-540014-000		
D102 Silicon diode, 1N4148	264-543148-000		
D103 Silicon diode, 1N4148	264-543148-000		
D104 Silicon diode, 1N4148	264-543148-000		
D105 Silicon diode, 1N4148	264-543148-000		
D201 Silicon bridge rectifier, 25 a., 200 PRV	544504		
D301 Silicon diode, 1 a., 200 PRV	544012		
D302 Silicon diode, 1 a., 200 PRV	544012		
F201 Fuse, 4 ampere, 3AG	266-023304-000		
F202 Fuse, 4 ampere, 3AG	266-023304-000		
F203 Fuse, 4 ampere, 3AG	266-023304-000		
F204 Fuse, 4 ampere, 3AG	266-023304-000		
F301 Fuse, 5 ampere, slo-blo, 3AG	266-024205-000		
F302 Fuse, 3 ampere, 3AG	266-023303-000		
F303 Fuse, 3 ampere, 3AG	266-023303-000		
C101 33 μf, 25 v., 5% (selected) tantalum	238-282334-000		
C102 150 pf, 100 v., 10% disc	238151		
C103 0.1 μf, 100 v., 20% disc	224104		
C104 56 pf, 100 v., 10% disc	234560		
C105 22 pf, 100 v., 10% disc	234220		
C106 33 μf, 25 v., 5% (selected) tantalum	238-282334-000		
C107 0.1 μf, 100 v., 20% disc	224104		
C108 50 μf, 75 v. electrolytic	284500		
C109 22 pf, 100 v., 10% disc	234220		
C110 50 μf, 75 v. electrolytic	284500		
C111 0.1 μf, 100 v., 20% disc	224104		
C112 0.01 μf, 500 v., 20% disc	228103		
C113 0.01 μf, 500 v., 20% disc	228103		
C114 0.1 μf, 100 v., 20% disc	224104		
C115 0.1 μf, 100 v., 20% disc	224104		
C201 150 pf, 100 v., 10% disc	238151		
C202 0.1 μf, 100 v., 20% disc	224104		
C203 0.02 μf, 500 v., 20% disc	227203		
C301 10,000 μf, 80 v. electrolytic	284109		
C302 10,000 μf, 80 v. electrolytic	284109		
PL301 Lamp, #53	526053		
PL302 Lamp, #53	526053		
TS101 Thermal sensor	316-530075-000		
T301 Transformer, power	328-464090-000		
S301 Switch, power	314-334021-000		

### 240 VOLTS AC WIRING

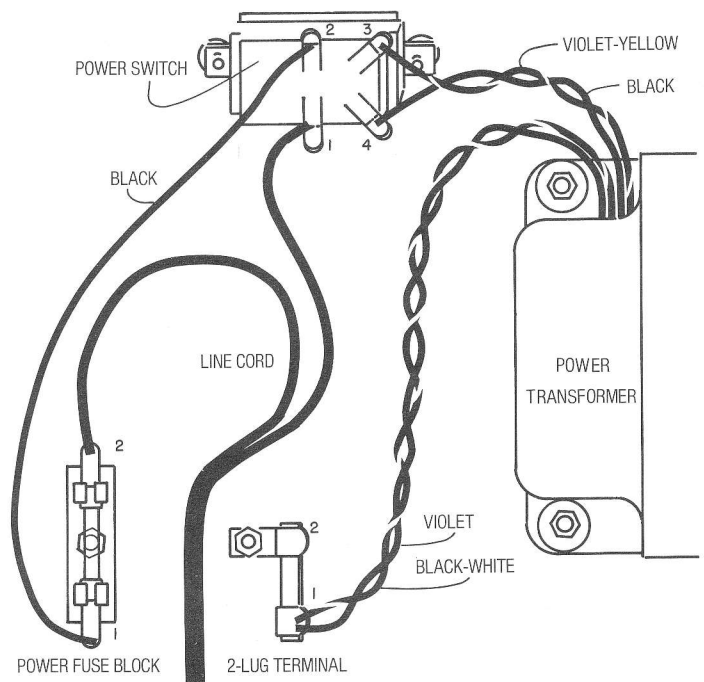

- 31( ) Prepare a  $3\frac{1}{2}$ " (9 cm) blue wire. Connect one end to hole #11 (S). Temporarily insert a toothpick into hole #10, if desired. Bend a small hook around the other end, and connect it to Q12A lug C (S-2).
- 32( ) Prepare a  $3\frac{1}{4}$ " (8.5 cm) black wire. Connect one end to hole #7 (S). Connect the other end to Q12A lug B (S).
- 33( ) Prepare a 4" (10 cm) yellow wire. Connect one end to hole #6 (S). Connect the other end to T-2 lug #9 at the tip.
- 34( ) Prepare a  $2\frac{1}{4}$ " (6 cm) yellow wire. Connect one end to T-2 lug #9 at the tip (S-2). Connect the other end to Q11A lug E.
- 35( ) Select the remaining diode, part #544012. Cut the lead on the marked end to  $\frac{3}{4}$ " (2 cm), cut the other lead to  $\frac{1}{2}$ " (1.3 cm) and bend the leads  $90^\circ$  to its body. Connect the lead without marking to Q11A lug E (S-2). Connect the marked lead to the notch in Q11A lug C. Note that the marked end of this diode and the one connected to Q12A point in opposite directions.
- 36( ) Prepare a  $5\frac{1}{4}$ " (13.5 cm) blue wire. Connect one end to hole #3 (S). Temporarily insert a toothpick into hole #2, if desired. Bend a small hook around the other end, and connect it to Q11A lug C (S-2).
- 37( ) Prepare a 5" (13 cm) black wire. Connect one end to hole #9 (S). Connect the other end to Q11A lug B (S).

Gently but firmly turn the entire PC-36 board on its connected wires until the board forms about a  $90^\circ$  angle to the inside of the back panel. This will enable connection of the last two pairs of twisted wires, which should be kept relatively short.

- 38( ) Prepare two  $5\frac{3}{4}$ " (14.5 cm) yellow wires. Start with the wires even, and twist them uniformly together to within  $\frac{1}{2}$ " (1.3 cm) of the other ends. These twisted pairs, as well as the other twisted wires in this kit, should be uniformly twisted 3 full turns every 2" (5 cm). Connect one end of one of the wires to hole #28, which is near the center of the board (S). Connect the corresponding end of the other wire to the adjacent hole #27 (S). Connect the other end of one (either) of the wires to T-2 lug #8 at the tip (S). Connect the remaining free end to T-2 lug #7 at the tip (S).
- 39( ) Prepare two  $5\frac{1}{2}$ " (14 cm) blue wires. Start with the wires even, and twist them uniformly together to within  $\frac{1}{2}$ " (1.3 cm) of the other ends. Connect one end of one of the wires to hole #30 (S). Connect the corresponding end of the other wire to the adjacent hole #29 (S). Connect the other end of one (either) of the wires to T-1 lug #2 at the tip (S). Connect the remaining free end to T-1 lug #1 at the tip (S).

The work you have finished should look much like the accompanying photograph.

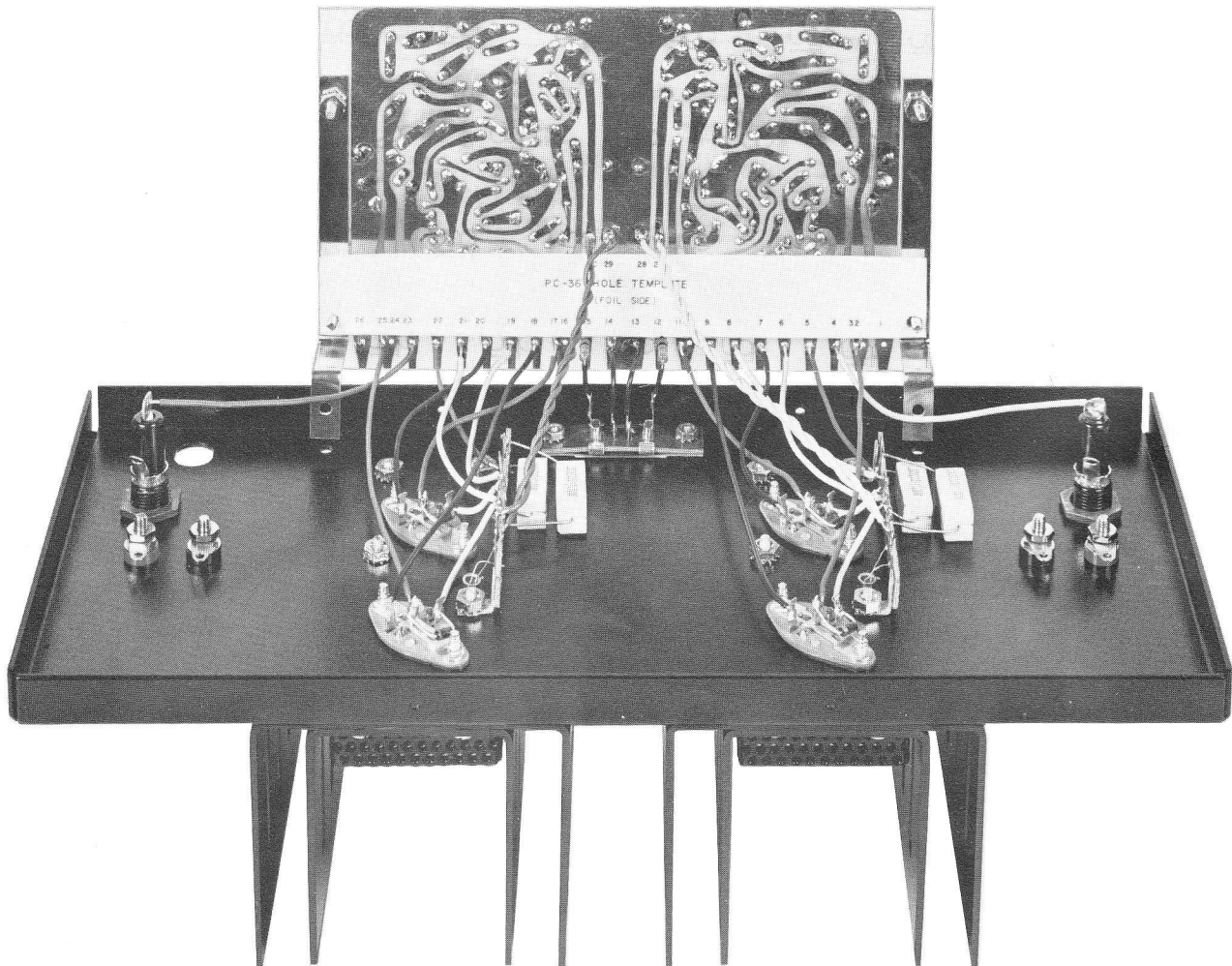

This completes the soldering to holes on the foil side of PC-36, and to most of the connections on the back panel. Now you should check all your connections. See that no solder blobs or excess wire connects other than the intended terminal. Cut off any excess wire on the other side of a connection with your side cutters. Turn the assembly over and cut off any excess wire (more than  $\frac{1}{16}$ "—.2 cm) from the soldered holes on the board.

The following holes and lugs are without connection: PC-36 holes #1, #2, #10, #16, #24 and #26; terminal strips T-1 lug #5 and T-2 lug #11; speaker fuse holder lugs #1 and #4; all binding posts.

40( ) Select two sets of #6 hardware. Remove the paper template from PC-36, if used. Turn the board on its wires until the board is approximately in its final position parallel to the inside of the back panel. Insert screws in the two remaining small holes in the back panel from the outside (ignore the holes in the flanges), then through the holes in the Z-brackets, and secure the brackets to the back panel with the nuts on the inside. Guide the blue wire to speaker fuse holder lug #2, and the yellow wire to fuse holder lug #3 so that they do not interfere with the brackets. See that the PC-36 board is parallel to the back panel.

Set the assembly aside. Your Stereo 150 is more than half completed.

## POWER SUPPLY BOARD WIRING

You will next install all the power supply parts on circuit board PC-37. White markings, lines and hole numbers on the *front* of the board indicate the placement of each part and where the leads of the parts or wires are inserted. Many of them are installed from this marked side. Only eight fuse clips, the small L-bracket, and eight wires are mounted on the unmarked *back* of the board. The parts mount against the board, just as the parts are mounted on the preassembled PC-36 circuit board.

Each part is identified by a part number, color code, or written value. Bend the leads of the resistors as required to fit the space between the marked holes. Then push the leads through the holes and spread them slightly to hold the part in place for soldering. The capacitors, fuse clips and Molex® connectors are pushed into the holes and held in place for soldering. Make certain that the solder flows all around the lead or connection smoothly onto the foil, without bridges or links of solder to other parts of the circuitry. Cut off excess leads.

Solder each lead or connection carefully to *both* sides of the board, unless indicated otherwise. There is no substitute for good soldering technique.

Place the PC-37 board in front of you, positioned with the unmarked *back* side facing up, as shown in the accompanying sketch.

1( ) Select the eight metal spring fuse clips, and the four 4 ampere fuses (the fuse rating is marked on one of its metal ends). The flat portion of each fuse clip has two tabs which fit into holes on the board. There are four holes in each of eight clusters of holes adjacent to F201, F202, F203 and F204 (these numbers are identified on the front of the board). *Only two of these holes per cluster are to be used, depending on the location of the tabs in the fuse clips.*

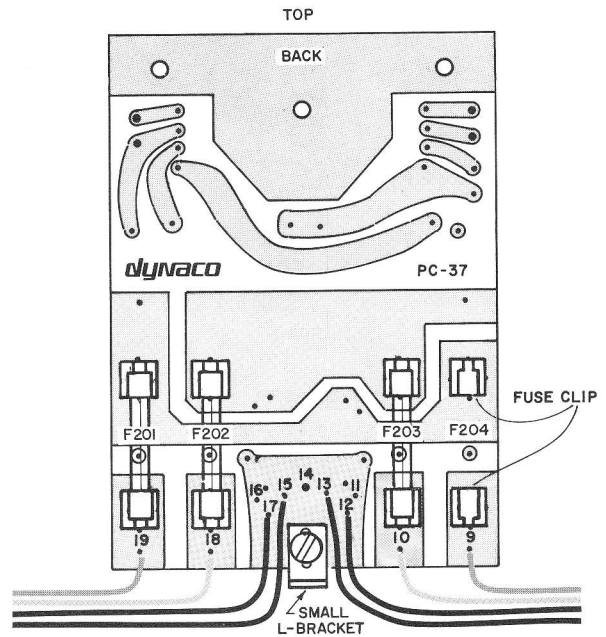

Notice also that a restrictive metal indent is provided on each clip so that the fuse can be installed only one way. Insert four of the clips at the bottom of the board so that their restrictive indents are nearest the bottom. Insert the remaining four clips above them in the appropriate holes so that their restrictive indents are nearest the top. Snap the four fuses into the fuse clips to assure correct placement of the clips, and to hold them in position against the board for soldering. Turn the board over (front side), and solder all sixteen tabs. You will not be able to solder them on the back of the board. If you prefer, you may leave the fuses installed, but use care handling the board in future steps, as the fuses are somewhat fragile.

- 2( ) Prepare a 4" (10 cm) blue wire. Connect one end to hole #19 on the unmarked *back* side at the bottom of the board. Solder *both* sides of the board. The other end of this wire, and the wires in succeeding steps, remain unconnected at present.
- 3( ) Prepare a 3½" (9 cm) yellow wire. Connect one end to hole #18. Solder both sides.
- 4( ) Prepare an 8" (20 cm) black wire. Connect one end to hole #17. Solder both sides. Somewhat more heat is necessary to connect this wire, and the other *black* wires in succeeding steps, because of the relatively large area of common foil circuitry. *Good soldering is essential*, for these black wire connections comprise the main ground for the entire amplifier.
- 5( ) Prepare a 5" (13 cm) black wire. Connect one end to hole #15. Solder both sides. Do not confuse this with hole #14, which is larger and in the center at the bottom. Hole #14 *must* remain without connection at present.
- 6( ) Prepare another 5" (13 cm) black wire. Connect one end to hole #13. Solder both sides.
- 7( ) Prepare an 8" (20 cm) black wire. Connect one end to hole #12. Solder both sides.

- 8( ) Prepare a 3½" (9 cm) yellow wire. Connect one end to hole #10. Solder both sides.
- 9( ) Prepare a 4" (10 cm) blue wire. Connect one end to hole #9. Solder both sides.
- 10( ) Select the small L-shaped bracket and a set of #6 hardware. Install the bracket on the back of the board with the screw through the *elongated* hole with the other end of the bracket turned up. Attach a nut on the front of the board, but do not fasten the hardware more than finger tight.

The next steps will refer to the diagram below of the front of PC-37.

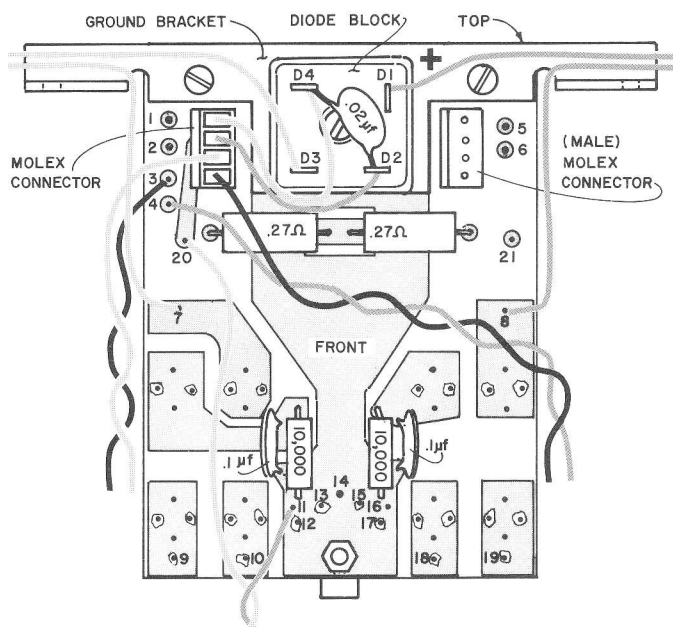

- 11( ) Install the two 10,000 ohm 1 watt resistors (brown-black-orange) in positions R203 and R204 against the front of the board. Solder all 4 leads on both sides.
- 12( ) Install the two .1 μf disc capacitors in positions C201 and C202 (do not confuse them with the single .02 μf disc capacitor). Solder all 4 leads only on the back of the board.
- 13( ) Install the two .27 ohm, 5 watt resistors in positions R201 and R202. *Do not place them against the board, but allow the leads to support them 1/8" (.3 cm) above the board.* Solder all 4 leads on both sides.
- 14( ) Install the two identical male Molex® connectors in positions P201 and P202 so that the plastic retainers are to the left and the pins are to the right. Solder all 8 pins on the back.
- 15( ) Select the T-shaped heavy aluminum ground bracket and two sets of #6 hardware. Install the bracket against the front of the board so that the two bent ends turn toward you. Insert screws first through the bracket from the front, then through the board, and fasten on the back with nuts. Tighten the hardware *very* firmly.

- 16( ) Select the one inch square diode block, the single ¾" #6 screw, a black flat washer, and a nut. Note that the terminals of the block are identified "+", "-", and (two) "AC". The block will be mounted against the ground bracket at the top with the "+" terminal (which may be identified by a red dot) over the tiny hole in the ground bracket on the right near the top. *Make certain this diode block is correctly positioned.* Place the washer first on the screw, insert the screw through the block, then through the bracket and board, and fasten on the back with a nut. Recheck the location of the "+" terminal and tighten the hardware securely.

- 17( ) Prepare a 3¾" (9.5 cm) yellow wire. Connect one end to diode block lug D3 (S). A considerable amount of heat is required to solder the lugs on the diode block.
- 18( ) Prepare a 4¼" (11 cm) yellow wire. Connect one end to hole #7 on PC-37. Solder both sides.
- 19( ) Prepare a 3½" (9 cm) blue wire. Connect one end to diode block D1 (S).
- 20( ) Prepare a 4¼" (11 cm) blue wire. Connect one end to hole #8. Solder both sides.
- 21( ) Prepare an 11" (28 cm) yellow wire, and a 12" (30.5 cm) blue wire. Start with the yellow wire 2" (5 cm) longer than the blue wire, and twist them uniformly together to within 1" (2.5 cm) of the other end of the yellow wire (the blue wire should be about 3" [7.5 cm] longer than the yellow wire at this end). Connect the end of the yellow wire 2" (5 cm) longer to hole #20. Solder both sides. Connect the corresponding end of the blue wire to hole #11. Solder both sides. [If meters are being installed, skip this step.]

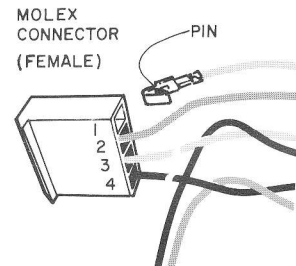

Set the assembly aside for a moment. Select the single plastic female Molex® connector body, and the four connector pins. The following four steps refer to the sketch on the right.

- 22( ) Prepare a 3½" (9 cm) yellow wire, but remove only 1/8" (.3 cm) of insulation from one end, and the normal ¼" (.6 cm) from the other end. Select one of the small connector pins, and place the shorter stripped end in the open "U" end of the pin for not more than ¼" (.6 cm)—to the end of the U-section. Solder the wire, but do not flow solder into the spring portion of the pin. Then crimp the "U" closed over the insulation with pliers.

A pin is assembled into the plastic connector body by simply pushing it into a small rectangular opening in the end. The pin itself is metal bent in the shape of a triangle. The back of the pin contains a tiny "barb" so that once the pin is installed, it cannot be easily removed. Therefore, be doubly certain that you install the correct pin into each hole before pushing it home.

Position the connector body and the pin with yellow wire attached, as shown in the sketch, and insert the pin all the way into connector opening #1.



- 23( ) Prepare a 3" (7.5 cm) blue wire, but remove  $\frac{1}{8}$ " (.3 cm) of insulation from one end, and the regular amount from the other. Select another connector pin and, as before, solder the wire to the pin and crimp the "U" closed. Insert the pin all the way into connector opening #2.
- 24( ) Prepare a 14" (35.5 cm) yellow wire, but remove  $\frac{1}{8}$ " (.3 cm) of insulation from one end, and the regular amount from the other. Prepare an 11 $\frac{1}{2}$ " (29 cm) black wire as usual. Start with the short-stripped end of the yellow wire 3" (7.5 cm) longer than the black wire, and twist them uniformly together to within 1" (2.5 cm) of the other end of the yellow wire (the black wire should be about  $\frac{1}{2}$ " [1.3 cm] longer). Select a third connector pin. Solder the yellow wire with the short insulation removed to the pin and crimp the "U". Insert the pin all the way into connector opening #3. The other wire will be connected later.
- 25( ) Prepare a 15" (38 cm) black wire, but remove  $\frac{1}{8}$ " (.3 cm) of insulation from one end, and the regular amount from the other. Prepare a 13 $\frac{1}{2}$ " (34.5 cm) blue wire as usual. Start with the short-stripped end of the black wire 3" (7.5 cm) longer than the blue wire, and twist them together to within 1" (2.5 cm) of the other end of the black wire (the blue wire should be about  $\frac{1}{2}$ " [1.3 cm] longer). Select the remaining connector pin, solder the black wire with the short insulation removed to it, and crimp. Insert the pin into connector opening #4.

Select the partially completed PC-37 assembly, and plug the female Molex® connector into the male Molex® connector adjacent to hole #1, #2, #3 and #4 on the board.

- 26( ) Connect the free end of the yellow wire from connector pin #1 to diode block D4.
- 27( ) Strip a 1" (2.5 cm) piece of insulation from the roll of black wire, and cut it in half. Select the .02  $\mu$ f disc capacitor and cut its leads to  $\frac{3}{4}$ " (2 cm) each. Slip a length of insulation onto each lead. Connect one lead to diode block D4 (S-2). Connect the other lead to diode block D2.
- 28( ) Connect the free end of the blue wire from connector pin #2 to diode block D2 (S-2).
- 29( ) Locate the yellow wire from connector pin #3, and connect the corresponding end of the black wire from this twisted pair to hole #3 on PC-37. Solder to the back of the board.
- 30( ) Locate the black wire from connector pin #4, and connect the corresponding end of the blue wire from this twisted pair to hole #4. Solder to the back of the board.

This completes most of the soldering to the PC-37 power supply. Now is the time to check all your connections. No solder blobs or excess wire should connect other than the intended terminal. Cut off any excess wire on the other side of a connection with your side cutters. Make certain that the connections to the common circuitry at the bottom of PC-37, holes #11 through #17, are secure, but observe that holes #14 and #16 are unconnected. The wire lengths to the Molex® connector may seem long, but they are necessary if you wish to operate the amplifier in the monophonic mode, which necessitates moving the connector to the pins on the other side of the diode block.

## FINAL ASSEMBLY

Place the main chassis in front of you, positioned as shown in the Pictorial Diagram. Also place the PC-37 power supply assembly flat against the chassis, diode block facing up, with the small L-shaped bracket toward the front of the chassis. All wires connected to the power supply should lie behind (to the back of) the large capacitors C-1 and C-2.

The secondary voltage leads of the power transformer comprise two red leads, two orange leads, and one red-yellow lead. All of them connect to PC-37.

- 1( ) Connect the red-yellow lead to hole #14. This is the large hole at the bottom in the center. You may shorten this lead if you wish, and then solder the lead securely on both sides.

Place the power supply assembly in its final upright position, and position the numerous wires from it so they point in the correct direction for eventual connection. The blue and yellow twisted pair should point toward the front right of the chassis; the blue and black pair should point to the back left of the chassis tucked under the board; the yellow and black pair should point to the back right, also under the board. The wires connected to the back of the board should all point toward the back of the chassis.

- 2( ) Select the remaining #6 screw and a nut. Attach the small L-shaped bracket to the chassis. Insert the screw from the outside, and fasten *loosely* with the nut on the inside.
- 3( ) Select two of the  $\frac{3}{8}$ " #10 SEMS screws (with lockwashers attached). Install the heavy ground bracket on capacitor terminals C1 lug #2, and C2 lug #3 with the screws. See that the capacitor terminals are all in line, and *very firmly* tighten the screws.
- 4( ) Tighten all the rest of the hardware which connects together the power supply assembly, capacitors C1 and C2, and the chassis. Tighten the L-bracket to the chassis first, and then the L-bracket to PC-37. Finally clamp the capacitor brackets around the capacitors, and then secure them to the chassis. Make certain that the L-bracket is very firmly connected to both the board and the chassis, and that the heavy ground bracket is very firmly connected to the capacitors.
- 5( ) Twist together the two red leads from the power transformer. Do not confuse them with the orange leads, which will be called for in the next step. Connect one (either) red lead to hole #6, and connect the other red lead to hole #5 from the front of the board. Solder both leads on the back.
- 6( ) Twist together the two orange leads from the power transformer. Connect one (either) lead to hole #2, and the other to hole #1 from the front. Solder both leads on the back.
- 7( ) Select the two ground lugs, and the remaining two #10 SEMS screws. Install the ground lugs on capacitor terminals C1 lug #1 and C2 lug #4, positioned as shown in the Pictorial Diagram. See that the screws are very tight.
- 8( ) Connect the free end of the blue wire from hole #8 on the board, and the free end of the blue wire from diode block lug D1, both to the ground lug on C1 lug #1 (S-2).

- 9( ) Connect the free end of the yellow wire from hole #7, and the free end of the yellow wire from diode block lug D3, both to C2 lug #4 (S-2).
- 10( ) Select the yellow and blue twisted pair from the board. Connect the free end of the yellow wire to lamp bracket lug #1 on the front panel (S). Connect the free end of the blue wire to lamp bracket lug #4 (S). [If meters are being installed, skip this step.]
- 11( ) Select the 220 ohm 3 watt resistor, and cut its leads to 1" (2.5 cm) each. Connect one lead to lamp bracket lug #2 (S). Connect the other lead to lamp bracket lug #3 (S). [If meters are being installed, ignore this step.]
- 12( ) Select the back panel assembly, and two black sheet metal screws with Phillips heads. Place the panel in position at the back edge of the chassis, after bending the several single and twisted pairs of leads away from the panel at the bottom. Insert the screws only in the corner hole at each end. The screws cut their own thread and therefore some force is required. Do not tighten the screws completely so the panel can be tilted outward for working.
- 13( ) Select the blue and black twisted pair from the PC-37 power supply board. Connect the free end of the black wire to left speaker fuse holder lug #1 (S). Connect the free end of the blue wire to left binding post lug #1 (S).
- 14( ) Select the long black wire from hole #17. Connect the free end to left binding post lug #2 (S).
- 15( ) Select the yellow wire from hole #18 on PC-37. Connect the free end to hole #16 on the PC-36 amplifier board from the front (components side). See that the two wires to holes #16 and #17, which are connected together, are securely soldered.
- 16( ) Select the blue wire from hole #19 on PC-37. Connect the free end to hole #24 on PC-36 (S). See that the two wires to holes #24 and #25 are securely soldered.
- 17( ) Select the short black wire from hole #15. Connect the free end to hole #26 on PC-36 (S).
- 18( ) Select the yellow wire from hole #10 on PC-37. Connect the free end to hole #10 on PC-36 (S). See that the two wires to holes #10 and #11 are securely soldered.
- 19( ) Select the blue wire from hole #9 on PC-37. Connect the free end to hole #2 on PC-36 (S). See that the two wires to holes #2 and #3 are securely soldered.
- 20( ) Select the short black wire from hole #13 on PC-37. Connect the free end to hole #1 on PC-36 (S).
- 21( ) Select the long black wire from hole #12 on PC-37. Connect the free end to right black binding post lug #3 (S).
- 22( ) Select the yellow and black twisted pair from PC-37. Connect the free end of the yellow wire to right speaker fuse holder lug #4 (S). Connect the free end of the black wire to right red binding post lug #4 (S).

This completes the soldering to the PC-36 and PC-37 boards. All wires from PC-37 should be connected. Install the four 4 ampere fuses on PC-37, if you removed them earlier.

- 23( ) Select two black sheet metal screws with Phillips heads. Tilt the back panel into its upright position and secure it to the bottom of the chassis with the screws. Tighten all four screws used to secure the back panel to the chassis.
- 24( ) Select the line cord and the strain relief. Separate the two conductors of the line cord for about 2" (5 cm). Strip 1" (2.5 cm) of insulation from one conductor, and  $\frac{1}{4}$ " (.2 cm) from the other. Mark the line cord  $10\frac{1}{2}$ " (27 cm) from the stripped end with a pencil or pen. Bend the cord sharply back on itself at the marking so that a "V" is formed. Install the strain relief as shown in the sketch below. The small end of the strain relief faces the stripped end of the wire. With heavy pliers, crimp the two halves of the strain relief together around the wire to partially shape the wire before insertion. Now grasp the larger diameter portion of the strain relief with the tips of the pliers, squeeze it fully closed, and insert the combination from the outside of the back panel in the remaining large hole. Notice that the hole has slightly flat vertical sides, and therefore the strain relief installs easily in the cut-out with the cord horizontal. The strain relief snaps into its locked position when fully inserted.

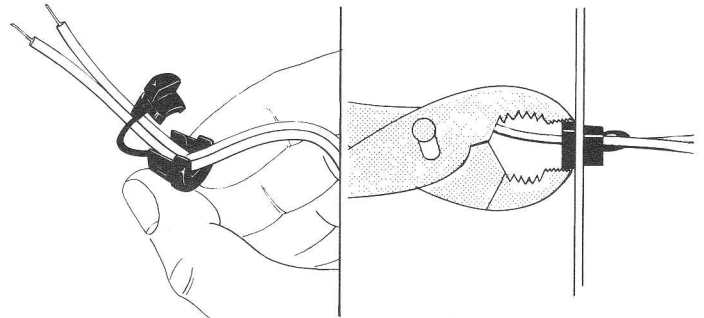

- 25( ) Select the conductor with 1" (2.5 cm) of insulation removed. Feed it through power switch lug #1 to power switch lug #2. Solder both lugs.

NOTE: If this unit is to be used with a 240 volts AC line, cut off  $\frac{3}{4}$ " (2 cm) of the conductor from which the 1" (2.5 cm) of insulation was removed, and connect it only to power switch lug #1 (S).

- 26( ) Select the remaining conductor. Connect it to fuse block lug #2 (S).
- 27( ) Select the violet and the violet-yellow leads from the power transformer, cut them to 5" (13 cm) long each, and prepare their ends. Twist the leads together, and connect one (either) to power switch lug #3, and the other to power switch lug #4.

NOTE: If this unit is to be used with a 240 volts AC line, connect only the violet-yellow lead to power switch lug #3 (S). Then shorten the black-white lead to 5" (13 cm) and prepare its end. Twist the violet and the black-white leads together, and connect them both to the 2-lug terminal lug #2 (S-2).

- 28( ) Strip the insulation from a 1" (2.5 cm) wire, and bend the bare wire in a 1/2" (1.3 cm) wide "U". Connect one end to power switch lug #3, and the other end to power switch lug #4. Solder both wires at lug #3 and at lug #4.

NOTE: If this unit is to be used with a 240 volts AC line, skip step 28.

- 29( ) Select the black and the black-white leads, cut them to 7" (18 cm) long each, and prepare their ends. Twist the leads together, and connect them both to fuse block lug #1 (S-2).

NOTE: If this unit is to be used with a 240 volts AC line, connect instead only the black lead to power switch lug #4 (S). (The black-white lead has already been connected.) In addition, prepare a 5" (13 cm) black wire. Connect one end to power switch lug #2 (S). Connect the other end to fuse block lug #1 (S).

- 30( ) Select the two strapping jumper connector pins. Prepare a 2" (5 cm) yellow wire, but remove only 1/8" (.3 cm) of insulation from both ends. As with the Molex® pins, solder one end of the wire to the open "U" end of one of the pins, and then crimp the "U" closed. Repeat with the remaining pin and the other end of the wire.

This jumper assembly is used only if the amplifier is to be operated as a monophonic 150 watt unit. To keep the jumper in a safe place, we suggest affixing it to the chassis with tape.

This completes the wiring of your Stereo 150. Note that when the unit is wired for 120 volts AC line, the 2-lug terminal is unused. You should check carefully for any insecure connections, and for any possibility of bare wires contacting other than the intended terminal. Turn the unit upside down and shake out any bits of solder or pieces of wire or insulation.

- 31( ) Install the two #53 bayonet lamps in the lamp brackets on the front panel. They merely push in and turn. [If meters are being installed, skip this step, and refer now to the MC-2 instructions before continuing with the next step.]
- 32( ) Install the 5 ampere Slo-Blo fuse in the power fuse block.
- 33( ) Install the two 3 ampere fuses in the speaker fuse holders on the back panel.

Prior to installing the decorative front plate, the cover, and the wood side panels, you may wish to test the amplifier. See that the power switch is turned off, plug the line cord into a wall outlet, and turn the power switch on. It is safe to operate the Stereo 150 without connection to the inputs or the outputs. If the lamps glow and the fuses hold, there are no gross faults. Unplug the amplifier and finish your work. If the fuses fail, check your wiring and refer to the IN CASE OF DIFFICULTY section of this manual.

- 34( ) Select the extruded aluminum front plate, and the self-adhesive decorative aluminum strip. Place the extruded plate in front of you. Peel off the backing from the strip. Using the ends and bottom lip of the front plate as a guide, affix the strip to the plate. Since the strip cannot be moved once it is installed, you may wish to first try a "dry run" with the backing in place prior to final installation.

- 35( ) Select the small piece of blue plastic. Turn the front plate over, and affix the plastic in the rectangular POWER opening. The adhesive on the back of the decorative strip will hold the plastic flat against it. [If meters have been installed, skip this step.]

- 36( ) Install the front plate on the front panel by securing it with the remaining five flat head screws and nuts. Insert the screws from the front through the *counter-sunk* holes, and tighten the nuts on the inside.

- 37( ) Install the dark pewter color decorative strip in the top section of the front plate. It slides in place from either end. [If meters have been installed, insert instead the dark plastic strip supplied with the meter kit.]

- 38( ) Make sure the back panel is clean under the Dynaco address. Remove the backing from the serial number label and affix it to the back panel under the address.

The general placement of wires should conform closely to the photograph below of the inside of the chassis.

- 39( ) Slide on the cover so that its bottom flanges fit inside the chassis, and the perforated section lies over the two circuit boards at the back. Secure it with the remaining seven black Phillips head sheet metal screws—3 screws at the front and 4 at the back. CAUTION: Sheet metal screws are *not* used between the cover and the chassis.

- 40( ) Install the two wood panels on the sides of the unit. The cutout section in the wood faces front, and notice that one panel is drilled for the left side, and the other for the right. Use the remaining six flat black washers and the six 5/8" #6 black Phillips head screws.

- 41( ) Remove the protective tape, if used as suggested earlier, from the edges of the heat fins.

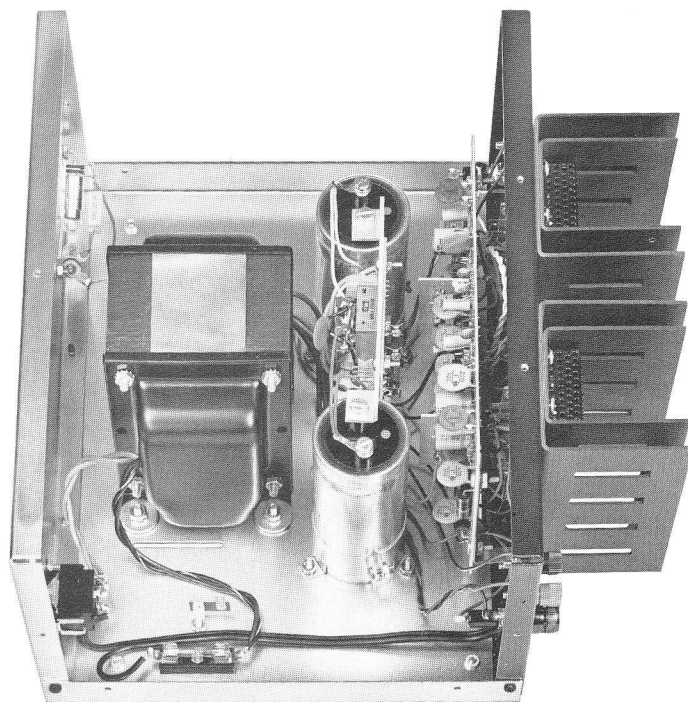

## THE MC-2 ACCESSORY METER OPTION KIT

The optional meter kit is most easily installed at step 31 of the Final Assembly instructions, before continuing to step 32.

The action of the meters supplied is "fast" enough to respond to substantial musical peaks, but no meter can accurately indicate the magnitude of transient waveforms which occur in music. They are effective in determining electrical balance of stereo programming, but the very nature of stereo implies discrete information on each channel, so exact level matching rarely occurs. With sine wave test signals and an *accurate* 8 ohm load, the meter is a measure of output power. A square wave test signal puts out approximately 11% more voltage than the equivalent sine wave meter indication.

To protect the meters from "pegging" (overdrive), it is recommended that the 0 dB position of the meter range push button switches be used where the anticipated power levels are not known, and when starting any test. Switch-

ing to successively higher sensitivity ranges until the loudest passages indicate near "0" will yield the most information.

The accompanying chart lists 8 ohm load power outputs in watts for each meter range. For a 4 ohm load, the wattage should be doubled. For a 16 ohm load, the wattage should be halved. When the amplifier is wired for mono use, only the Channel B meter will read, and the power indicated remains the same as the chart below.

SCALE	METER RANGE			
	0 dB	-6 dB	-12 dB	-18 dB
+ 3	150	37.5	9.4	2.4
0	75	18.75	4.7	1.2
- 3	37.5	9.4	2.35	0.6
-10	7.5	1.87	0.47	0.12

### IN CASE OF DIFFICULTY

If there is an initial fault with your component system, or one develops in use, separate units enable relatively easy diagnosis of the source of the problem. Before blaming the electronics, check the connections on all components, particularly carefully on the preamplifier. See that the connections agree with the instructions supplied for each component. Check on the preamplifier that the monitor switch is in its normal or "input" position. If the Dynaco PAT-5 is used, also see that the E.P.L. switch is in its normally "out" position.

If neither channel works with any program source (phono, tuner and tape), it is unlikely that all sources would be faulty. To test whether the problem lies in the preamplifier, temporarily connect the audio cables from the tuner or tape deck to the inputs of the Stereo 150. Use the volume control or level set on the tuner or deck to adjust volume. If the system operates without the preamplifier, even after double checking its connections, the preamplifier is at fault. If the system is still defective, check the *speaker* fuses on the back panel of the Stereo 150 and the speaker connections at both ends. Also, if the amplifier's heat sinks are very warm, allow the unit to cool off and try again, for the thermal sensors may have reduced the input of the amplifier. If the amplifier is cool, and if the connections and the speaker fuses are all right, the fault lies in the Stereo 150.

A fault in only one channel suggests interchanging the audio cables channel for channel to determine the problem. If the fault occurs with only one sound source, such as phonograph, the problem cannot lie in the Stereo 150. Interchange the phono cables at the preamplifier. If the fault reverses channels, the problem is in the source. Check the phono cables, the connection of the cartridge in its mounting shell, and the connecting pins between the shell and the tone arm.

If the fault lies in one channel with any sound source, check the cables between the preamplifier and the Stereo 150, as well as the speaker wires and the speaker fuses. If these are not defective, connect the tuner or tape deck directly to the Stereo 150. If the problem goes away, the fault is in the preamplifier. If the fault remains, interchange the speakers channel for channel. If the problem follows a given speaker, the speaker is faulty. If the problem remains in the same channel regardless of the location of the speakers, one channel of the Stereo 150 is faulty.

Because 90% of the difficulties encountered with kit-built units can be attributed to incorrect wiring or poor solder connections, it is strongly recommended that you ask someone else to check your wiring against the Pictorial Diagram, for one person will frequently make the same error repeatedly.

There are certain general precautions to be observed when servicing any semiconductor equipment:

1. Never make circuit changes of any kind when the amplifier is turned on.
2. Be particularly careful not to short any transistor leads to each other or to the chassis when the power is on.
3. When using test equipment, you must avoid transient voltage peaks and excessive test voltages.
4. Exercise caution when soldering and unsoldering semiconductor leads to avoid excessive heat.

If circuit difficulties are encountered with the Stereo 150, the average kit builder will not likely be able to locate the source of the problem. **DO NOT ATTEMPT TO SERVICE THIS AMPLIFIER UNLESS YOU HAVE THE KNOW-HOW AND SUITABLE TEST EQUIPMENT.**

### CHECKING SEMICONDUCTORS

An ohmmeter can serve as a rough check for transistor or diode failure. The transistor must be removed from the circuit for this test. For the purposes of this test all transistors can be considered to be two diodes connected in series with common elements tied together. The junction point represents the base of the transistor.

With one ohmmeter probe connected to the base, the other probe should be connected to the collector and emitter in turn. Readings from the base to the collector, and from the base to the emitter should be similar. With one orientation of the probes, there should be a high resistance reading (almost an open circuit). When the polarity of the probes is reversed, there should be a relatively low reading. The high reading will appear with one orientation of the probes for a pnp transistor, and with the opposite orientation for an npn transistor. Then the ohmmeter should be connected from collector to emitter, and a high resistance should be read (almost open circuit), regardless of the orientation of the probes. If all these qualifications are met, the transistor does not exhibit any gross defects.

In similar fashion, diodes can be checked by verifying that they have a high resistance in one direction, and low resistance in the other.

## TESTS

The availability of a VTVM, TVM, or VOM with at least 20,000 ohms per volt sensitivity will enable you to make some checks to minimize the likelihood of trouble. Since each PC-36 circuit board has been checked in actual operation prior to packing into the kit, a component fault there is not likely. However, a splash of solder, poor or wrong connections, or broken or shorting components leads can result in failure.

The following resistance reading should be made with the amplifier unplugged, and with all four B+ fuses and the two speaker fuses removed from the circuit:

1. From the *bottom* of the B+ and B- fuse clips to ground: over 4,000 ohms.

Large variations are possible because of differences in types of meters, and variations in output transistors.

If a reading is low, remove the two wires on PC-36 which correspond to the trouble source. (B+ for left channel is holes #2 and #3; B- for the left channel is holes #10 and #11; B+ for the right channel is holes #24 and #25; B- for the right channel is holes #16 and #17.) Check from these holes to ground, and the associated output transistor to determine which is causing the low reading. If the board is at fault, check for solder splashes, bad connections, or defective components. If the output stage is at fault, check for shorts between the transistor case or its pins and the heat sink, or for a defective transistor.

If the reading is very high, examine the circuit for open connections or an open transistor on the board or output stage.

## NO SOUND OUTPUT

A blown fuse is the most likely cause of interrupted sound in one (or both) channels. First check the speaker fuses, then the power fuse, and finally the B+ fuses. A failed speaker fuse usually indicates that you have driven the system at a high enough level to "pop" the fuse. Replacement should restore sound. However, the failure of either the power fuse or the B+ fuses usually indicates more than routine difficulty. When one of these fail, take B+ and B- resistance readings, as outlined above, to find the source of the trouble.

## BIAS ADJUSTMENT

The output bias current has been set at the factory, and should remain in proper adjustment for the life of the amplifier. However, should you wish to check the output bias, the following procedure should be followed:

1. Remove the input connections, and also the load from the output connections.
2. Remove the B+ fuse from the channel to be adjusted (you should not remove the B- fuse).
3. Connect the "+" lead of an ammeter to the upper fuse clip, and the ground lead to the lower fuse clip. Avoid shorting out the leads or allowing them to make intermittent connections.
4. Turn the unit on, wait about 10 seconds, and adjust the B+ current (trimpot P102) for approximately 120 milliamps.
5. Leave the amplifier on for 10 minutes until operating temperatures have stabilized. With a volt meter connected to the output terminals, set the center line voltage (trimpot P101) for 0 volts ( $\pm 20$  millivolts).
6. Once again check the B+ current. It should have dropped to about 75 milliamps. If not, readjust to that value.

Repeat the procedure for the second channel. Since the amplifier's voltages will have been stabilized, the B+ current may first be set to about 75 milliamps, and then wait 2-5 minutes before adjusting the center line and finally rechecking the B+ current.

NOTE: The actual current through the output transistors is 25 milliamps less than the total B+ current through the output stage. By adjusting the B+ current for 75 milliamps, optimum bias of 50 milliamps is achieved.

## VOLTAGES

With exception of the power transformer, all power supply components are located on the PC-37 circuit board. The chart below lists the voltages and the location of the test points. The values are based on a 120 volt, 60 Hz line, amplifier connected in stereo, shorted input, no load connected to the output. All voltages are with respect to circuit ground. Tolerance: 20%.

VOLTAGE	PC-37 CIRCUIT LOCATION
37 v. AC	Hole #1, #2, #20
48 v. AC	Hole #5, #6, #21
+50 v. DC	Hole #8, #9, #19
-50 v. DC	Hole #7, #10, #18
GROUND	Hole #11, #12, #13, #14, #15, #16, #17

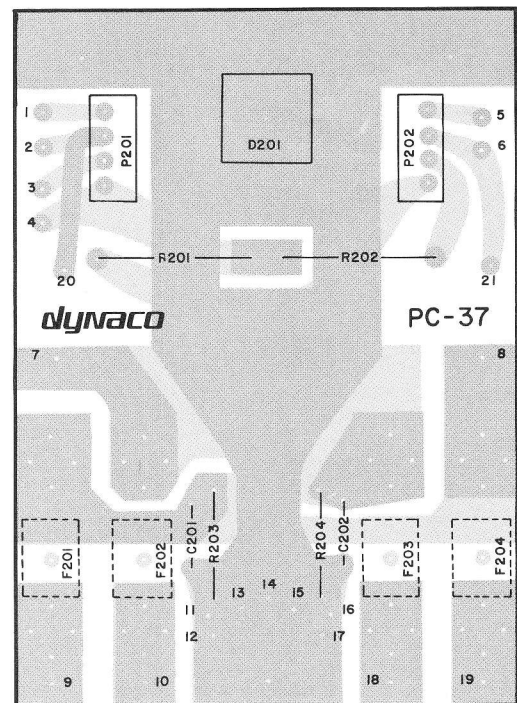

NOTE: When measuring voltages, it is important to take volt meter accuracy into account. Most volt meters are specified for accuracy with respect to the range selected. This means, for example, that a voltage reading on  $\pm 5\%$  meter could be off by  $\pm 5$  volts on the 100 volt range. In the Stereo 150 this could imply an incorrect indication when measuring the DC supply, which has been specified  $\pm 10$  volts (with a 120 volt line). Even if the voltages were exactly 50 volts, a  $\pm 5\%$  meter reading could indicate a voltage from 35 to 65 and still be within the specifications of both the meter tolerance and the voltage tolerance. It is therefore necessary to always consider the tolerances of *both* the voltage being measured and of the measuring instrument.

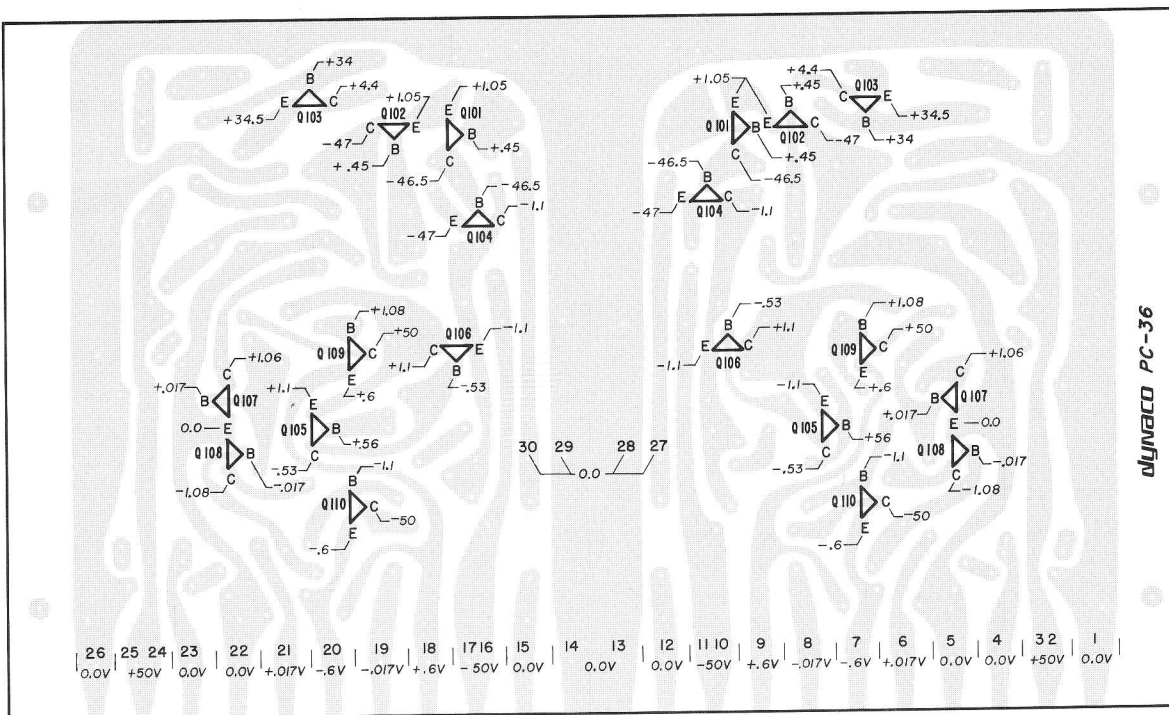
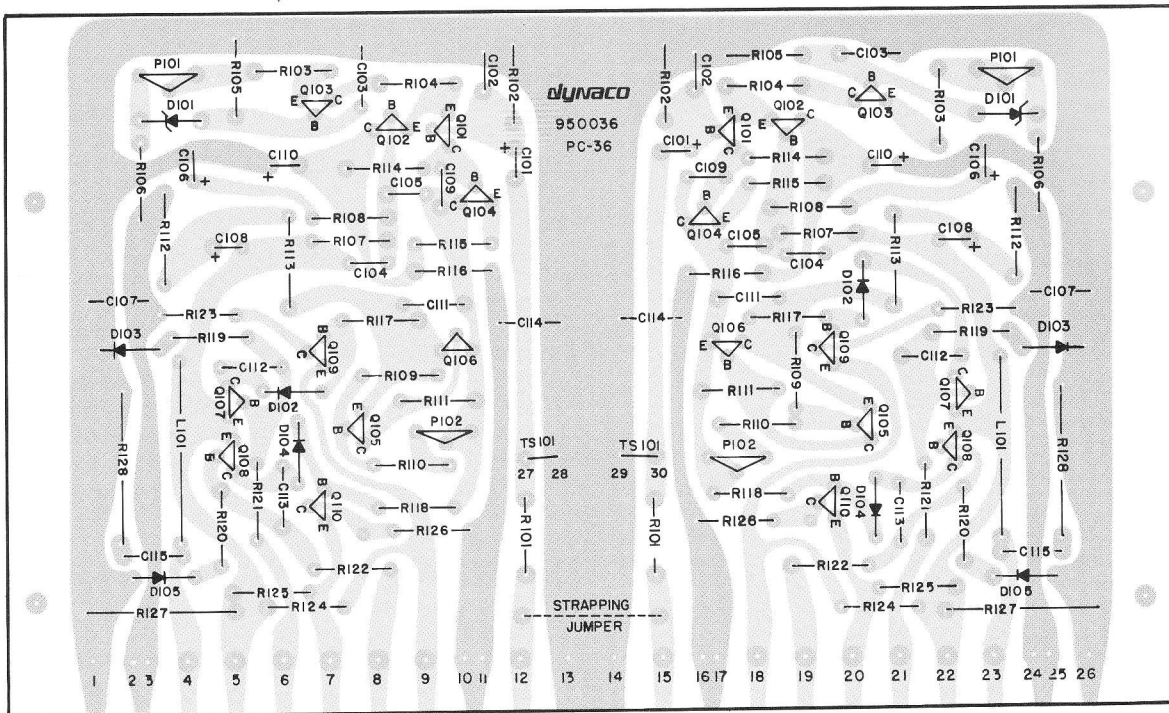

### 240 VOLTS AC LINE CONNECTIONS

The power transformer supplied in the Stereo 150 may be connected for a 220-240 volts AC line, as well as for the standard 120 volts AC line (the transformer is wired for 120 volts use unless this manual and the outer shipping carton are marked "240 volt"). The transformer has dual primary windings. They are connected in parallel for 120 volts, and in series for 240 volts. The notes to steps 25, 27, 28 and 29 on pages 18

and 19, the Pictorial Diagram on page 13, and the schematic diagram on page 12 detail the 240 volts connections.

The 5 ampere slo-blo fuse supplied with 120 volts wiring should be replaced with a 2½ ampere slo-blo fuse when it is wired for 240 volts use.

This amplifier may be used with either 50 or 60 Hz current.

## SERVICE POLICY AND LIMITED WARRANTY

The Stereo 150 has been carefully engineered to provide many years of musical enjoyment without difficulty. Each factory-assembled Stereo 150 has been subjected to a full complement of performance tests prior to shipment. Each PC-36 circuit board in the kit has been tested and adjusted in operation as a fully functioning unit to verify its performance capability. Nevertheless, through damage in transit, faulty kit assembly, or human error, service may sometimes be required.

To provide rapid and reliable service, Dynaco has authorized competent, well-equipped service facilities in several localities in the United States and Canada, in addition to its service facility at the factory. These stations are authorized to make repairs in and out of warranty under the terms listed below. Service is always available at the factory, but you will often find a more convenient facility locally. A current list of these facilities is enclosed. Write to Dynaco for the name of the service station nearest you.

It is the owner's responsibility to *take or send the unit freight prepaid to the service facility. A dated bill of sale must be submitted.* In the event that you incorrectly diagnose which unit is faulty, please understand that you will be responsible for a check-out charge on any properly performing kit or factory-assembled unit submitted for testing.

Shipment should be made via United Parcel Service (Express in Canada), whenever possible. **DO NOT USE PARCEL POST FOR IT IS NOT A SAFE METHOD OF SHIPPING ELECTRONIC EQUIPMENT.** Should damage occur because of parcel post shipment, repairs will be made at the owner's expense, as neither the factory nor the service stations has the facilities to process parcel post claims. Insure the carton for the full value of a *factory wired Stereo 150.*

When shipping the preamplifier, use the original carton with all the styrofoam inserts and plastic bag. Include with the returned unit the following information:

1. Your name and complete shipping address (Post Office box numbers are not suitable);
2. The serial number (from the cover of this manual), *together with a copy of your dated bill of sale;*
3. The symptoms, complete, but preferably brief. If the problem is intermittent, this *must* be noted.

Once service work has been performed, an additional 90 day unconditional warranty is provided, including shipment both ways.

Warranties apply to the original purchaser only; they are not transferable. They do not apply to units which have been physically or electrically abused, or to units which have been modified without prior written factory authorization. The use of non-Dynaco replacement parts may in some instances void the warranty. If you suspect a defect in the power transformer, the leads must be unsoldered, not cut for its return. The warranty on the transformer is void if the leads have been cut too short for re-use.

Dynaco maintains a Technical Services Department to help you locate the source of, and possibly correct a problem yourself. When writing, mention the serial number of the Stereo 150 and any tests you have performed.

### WARRANTY FOR KIT-BUILT UNITS

The components in a Stereo 150 kit are warranted for a full year from the purchase date. If a defective component is found in a completed circuit board module, or kit, simply return that individual part to the *factory* prepaid, and it will

be replaced at no charge. Local service stations are not obligated to supply separate parts.

If you cannot locate the source of the difficulty, ship the entire Stereo 150 to the nearest authorized service station or to the factory for service. A dated bill of sale must be submitted. In-warranty parts will be replaced at no charge, although a service fee will be charged for the labor to diagnose, correct, and test the unit to ensure that it meets factory specifications. Shipping charges to and from the service facility are the owner's responsibility. Units will be returned on a COD basis via UPS wherever possible.

*The return of a single circuit board for service to the factory or to an authorized service station is not adequate to assure proper operation, and a single circuit board submitted for repair will be returned unserviced.*

This warranty is void if the kit has not been completely assembled, or if other than rosin core solder has been used. Units assembled with acid core solder or paste flux will be returned unserviced.

### WARRANTY FOR FACTORY ASSEMBLED UNITS

The Stereo 150A is warranted for a full year from the purchase date, including parts and labor, and shipment costs *from* the service facility to the owner (within the U.S. or Canada). The owner is responsible for shipment *to* the service facility, and must submit a copy of the dated bill of sale.

### SERVICE BEYOND THE WARRANTY PERIOD

Dynaco establishes maximum labor fees which may be charged by its service facilities (plus the cost of parts, and shipping charges) without prior approval by the owner. A current list of authorized service stations, and the current established fee for any unit will be supplied by Dynaco on request. Dynaco cannot assume responsibility for service at other than *Dynaco authorized service stations.*

Dynaco reserves the right to limit the service facility or the established fees to two years from the date of purchase. Dynaco assumes no liability or responsibility for injury or damages sustained in the assembly or operation of this equipment, or for damage to other equipment connected to it. Dynaco reserves the right to make design changes without the obligation to revise prior versions. Prices and specifications subject to change without notice.

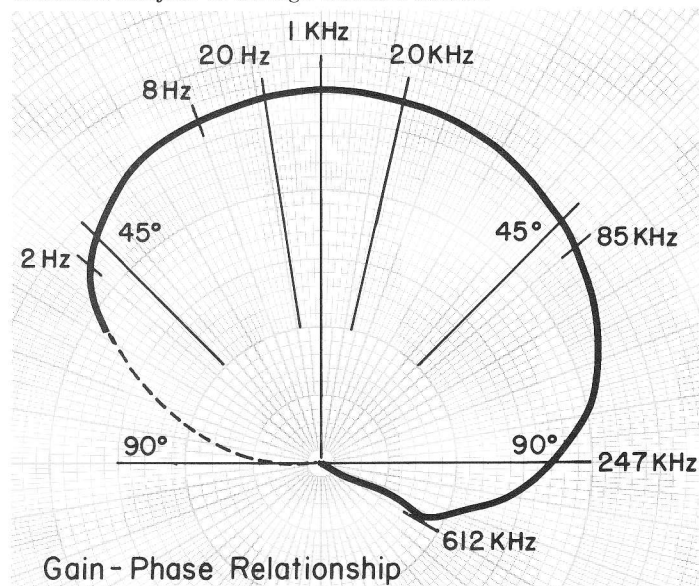

## PARTS LIST

Parts of a similar type which do not change performance will sometimes be included as a matter of expediency. This will account for slight variations in value and appearance.

	PART #			PART #
1 Back Panel, black, aluminum	078-711153-005	<i>Diode-Resistor Assembly</i>		613-000010-000
1 Chassis, plated, steel	021-000002-005	2 Connector, metal, PC-36 terminal		137-000002-000
1 Cover, black, steel (for chassis)	033-000002-002	4 Diode, plastic, small		544012
2 Cover, black, perforated (for transistors)	033-000001-000	2 Fuse, 3 ampere, AGC/3AG		266-023303-000
1 Front Panel, plated, steel	079-711152-000	1 Fuse, 5 ampere Slo Blo AGC/3AG		266-024205-000
1 Front Plate, aluminum extrusion	077-769150-002	2 Lamp, bayonet, #53		526053
1 Front Plate, insert, aluminum sheet	127-000003-000	4 Resistor, 0.33 ohms, 5 watts		306-120033-000
1 Front Plate, insert, pewter color	076-000005-000	1 Resistor, 220 ohms, 3 watts		120221
2 Heat Fin, black, aluminum	612-000001-003	2 Resistor, 1000 ohms (brown-black-red)		113102
1 Panel, wood, left side	015-867038-000	2 Thermal Sensor, lug mounted		316-530075-000
1 Panel, wood, right side	015-867138-000			
2 Binding Post with hardware, black	315001	<i>PC-37 Assembly</i>		613-000011-000
2 Binding Post with hardware, red	315002	1 Bracket, small L shape		011-000003-000
2 Bracket, Z-shape, audio circuit board	011-000001-000	1 Capacitor, .02 $\mu$ f disc		227203
2 Bracket, round, capacitor	717003	2 Capacitor, .1 $\mu$ f disc		224104
1 Bracket, T-shape, heavy aluminum	011-000002-000	8 Clip, spring, fuse mounting		270-341009-000
2 Capacitor, 10,000 $\mu$ f	284109	1 Connector, plastic, Molex (female)		256-355018-000
1 Circuit assembly, PC-36 board	607-993036-000	2 Connector, plastic, Molex (male)		256-365018-000
1 Circuit, bare, PC-37 board	950037	4 Connector Pin, metal, Molex		256-355019-000
1 Diode Block, rectifier	544504	4 Fuse, 4 ampere, AGC/3AG		266-023304-000
4 Foot, rubber	039-000002-000	2 Resistor, 0.27 ohms, 5 watts		306-120027-000
2 Fuse Holder, round, with hardware	341001	2 Resistor, 10,000 ohms (brown-black-orange)		115103
1 Fuse Holder, rectangular, block type	341003			
1 Label, serial number, kit	509-000002-000	<i>Hardware Assembly</i>		613-000013-000
1 Line Cord	322092	3 #4-40 x $\frac{5}{16}$ oval head machine screw		611254
2 Socket, lamp	386001	3 #4-40 KEP nut (lockwasher attached)		615244
4 Socket, transistor	353001			
1 Socket Strip, dual input	355012	31 #6-32 x $\frac{1}{2}$ oval head machine screw		611385
1 Switch, power, black rocker	314-334021-000	1 #6-32 x $\frac{3}{4}$ oval head machine screw		611325
2 Terminal Strip, 6 lugs	136-375010-000	9 #6-32 x $\frac{3}{8}$ flat head machine screw		097-037556-122
1 Terminal Strip, 2 lugs	136-372001-000	6 #6-32 x $\frac{5}{8}$ Phillips head machine screw (black)		095-062556-525
1 Thermal Compound, capsule	945004	8 #6 x $\frac{3}{4}$ sheet metal screw (blunt tip)		612304
2 Transistor, 2N6029 or 2N6030	561356	15 #6 x $\frac{3}{8}$ Phillips head sheet metal screw (black)		108-037551-820
2 Transistor, 2N5629 or 2N5630	571104	7 #6 x $\frac{13}{32}$ Dia. flat washer (black)		141-325406-023
1 Transformer, power	328-464090-000	39 #6-32 KEP nut (lockwasher attached)		615304
1 Strain Relief, black plastic	895001			
1 Wire, #20 hookup, black, 8 ft. (2.4 m)		4 #8-32 x $\frac{3}{8}$ oval head machine screw		611465
1 Wire, #20 hookup, blue, 8 ft. (2.4 m)		4 #8 lockwasher		617405
1 Wire, #20 hookup, yellow, 8 ft. (2.4 m)				
1 Warranty Card		4 #10-32 x $\frac{1}{2}$ oval head machine screw		611584
1 Instruction Manual		4 #10-32 x $\frac{3}{8}$ SEMS machine screw (lockwasher attached)		613564
		4 #10 x $\frac{7}{8}$ Dia. flat washer		616005
		2 #10 ground lug		639309
		4 #10-32 KEP nut (lockwasher attached)		615504
<i>Insulator Assembly</i>	613-000012-000			
1 Insulator, input socket strip	801372			
4 Insulator, grey metal, transistor	272-000001-000			
1 Lamp Insert, plastic sheet, blue	148-000003-000			



# ST-150 PICTORIA

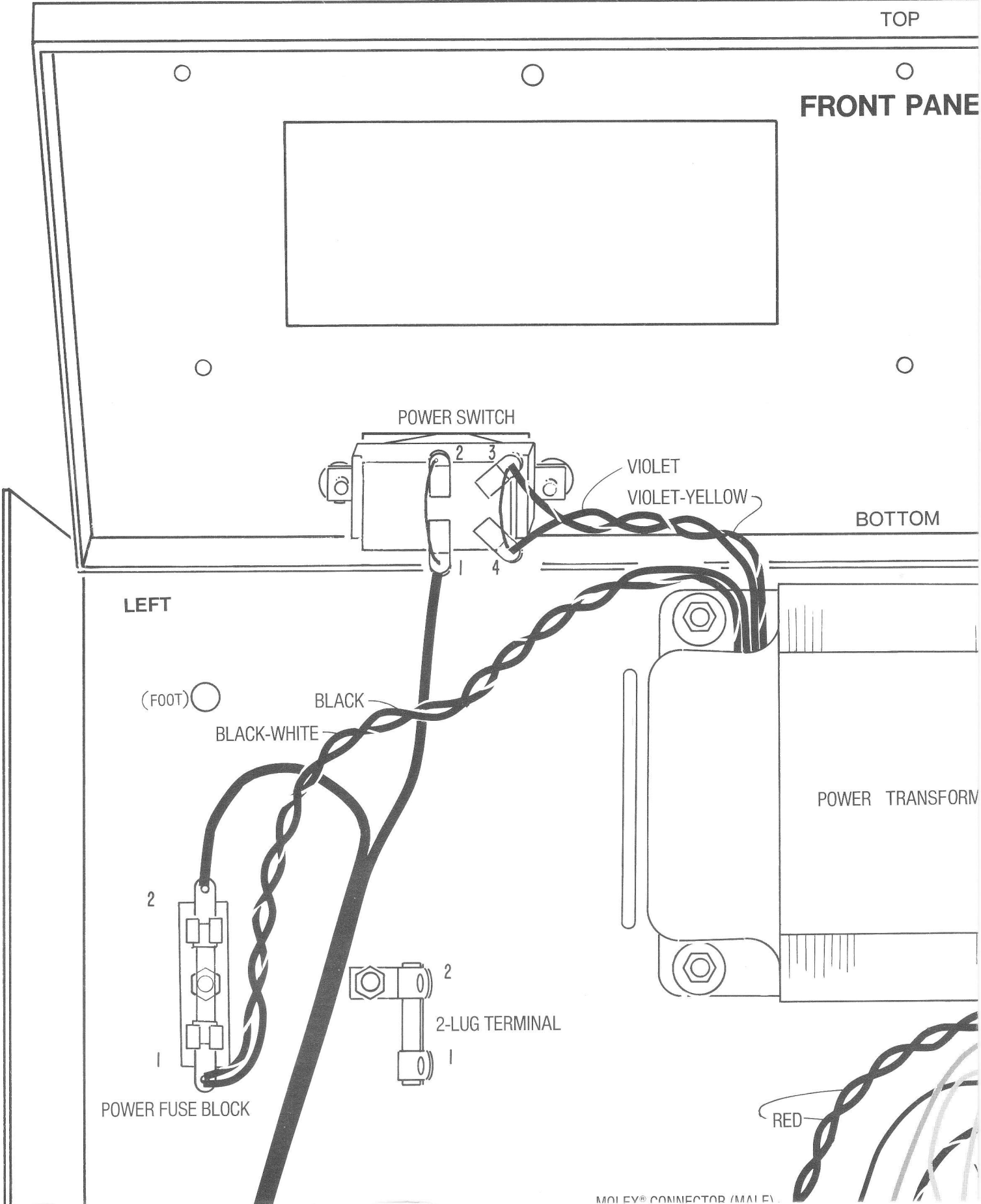

# WIRING DIAGRAM

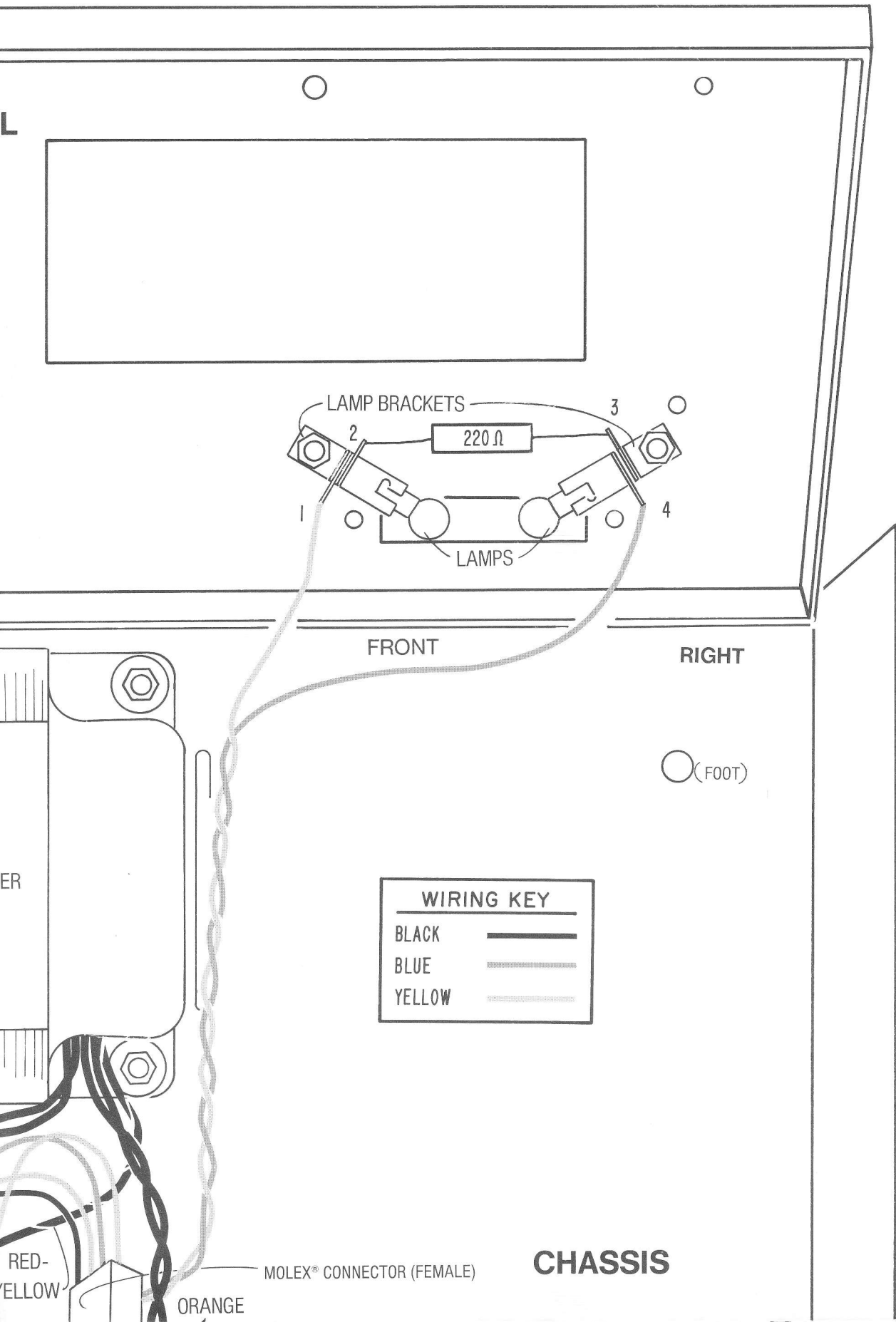

WIRING KEY	
BLACK	
BLUE	
YELLOW	

PC-36 HOLE TEMPLATE (FOIL SIDE)	
30	●
29	
28	
27	
26	●
25	
24	
23	
22	
21	
20	
19	
18	
17	
16	
15	
14	
13	
12	
11	
10	
9	
8	
7	
6	
5	
4	
3	
2	
1	

